

# APOLLO-D9™

## User Manual



# Contents



<b>Safety Information</b> .....	<b>iv</b>
<b>Customer Support / Links</b> .....	<b>vi</b>
<b>Section 1: Introduction / General Information</b> .....	<b>1</b>
About This Manual .....	1
Serial Number / Software Version .....	1
Specifications .....	1
Powering On/Off .....	2
Emergency Shutdown .....	2
Features and Buttons .....	3
Home Screen and Title Bar .....	4
Quick-Access Menu .....	5
Printing Data and Screenshots .....	5
Scrolling (Navigation) .....	5
Icon Reference Table .....	6
Battery Pack .....	7
Safety .....	7
Removal / Installation .....	8
Charging .....	8
Ordering a Replacement .....	9
Disposal (North America) .....	9
Care and Cleaning .....	10
Accessories .....	10
Diagnostic Quick Tips - Video Series .....	10
Training Videos (Online) .....	11
<b>Section 2: Companion Applications</b> .....	<b>12</b>
Snap-on Cloud .....	12
Authorization Codes .....	13
ShopStream Connect™ (Connecting to your PC) .....	13
SureTrack® (On PC) .....	15
<b>Section 3: Data Cable / Connections</b> .....	<b>16</b>
About Ethernet Equipped Vehicles and Data Cables .....	16
Data Cable Connection (OBD-II/EOBD Vehicles) .....	16

Data Cable Connection (OBD-I Vehicles) .....	18
Optional OBD-I Data Cables and Adapters .....	19
<b>Section 4: Scanner</b> .....	<b>20</b>
Quick Links .....	20
General Information .....	20
Scanner Control Icons .....	20
Secured Vehicle Gateway .....	21
Quick-Access Menu .....	21
Vehicle Voltage Readout .....	21
Basic Operations .....	22
Scanner Overview .....	22
Vehicle Identification .....	22
System and Test Selection .....	24
Working with Trouble Codes .....	25
Code Scan .....	25
Codes Menu .....	25
Display Codes .....	25
Freeze Frame/Failure Records .....	26
Clear Codes .....	26
Service Resets and Relearns .....	27
Working with Data (PIDs) .....	28
Data Menu .....	28
Custom Data Lists .....	28
PID (Alarm) Indicator .....	29
Data Views (List / Graph) .....	30
Locking PIDs (to always display at top) .....	30
About the Data Buffer .....	31
About Cursors .....	32
Pausing and Reviewing Active Data .....	32
Saving Data Files .....	33
Viewing Data Files .....	34
Using Zoom .....	34
Using Triggers .....	35
Functional Tests .....	38



Troubleshooter.....	38
<b>Section 5: Vehicle Code Scan .....</b>	<b>40</b>
Using Code Scan.....	41
Total Number of Systems (modules) Analyzed.....	42
List of All the Systems Analyzed with DTCs Totals.....	42
Global OBDII DTCs.....	43
Readiness Monitor Test Status.....	43
Vehicle System Report.....	44
Printing the Vehicle System Report.....	44
<b>Section 6: Intelligent Diagnostics .....</b>	<b>45</b>
Demonstration.....	45
Accessing Intelligent Diagnostics.....	46
Main Menu.....	46
Wi-Fi Status Indicator.....	47
Code Results Dropdown Menu.....	47
Top Repairs Graph.....	47
Technical Bulletins (OEM Information).....	48
Smart Data.....	49
About Smart Data PIDs.....	50
Functional Tests and Reset Procedures.....	51
Real Fixes.....	51
Troubleshooter.....	52
<b>Section 7: Quick Lookups.....</b>	<b>53</b>
Oil Specs and Resets.....	53
Operation.....	54
Fluid Capacity.....	54
Functional Reset.....	55
Reset Procedure.....	55
Tire and Wheel Service.....	56
Operation.....	57
<b>Section 8: Training and Support .....</b>	<b>60</b>
Training and Support.....	60
Setting up your Wi-Fi connection.....	60
Setting up the Snap-on Cloud.....	61
Sharing a pre and post scan report (Code Scan Report).....	61
Upgrading your device (Software Upgrades).....	61

<b>Section 9: OBD-II/EOBD.....</b>	<b>63</b>
OBD Direct.....	63
Start Communication.....	63
Connector Information.....	67
Manual Protocol Selection.....	67
OBD Training Mode.....	68
OBD-II Health Check.....	68
Global OBD-II Code Check.....	68
Global OBD-II Clear Codes.....	68
Readiness Monitors.....	69
MIL Status.....	69
<b>Section 10: Previous Vehicles and Data .....</b>	<b>70</b>
Vehicle History.....	70
Saved Data.....	71
Viewing /Printing Saved Codes and Code Scan Results.....	71
Delete Saved Data.....	71
<b>Section 11: Tools.....</b>	<b>72</b>
Tools Main Menu.....	72
Connect-to-PC (File Transfer).....	73
Get Connected.....	73
Configure Shortcut Key.....	73
System Information.....	73
Software Updates.....	73
Settings.....	74
System Settings (Display, Date & Time).....	74
Configure Scanner.....	75
Configure Wi-Fi.....	76
Configure Units.....	76
<b>Section 12: Wi-Fi Connection / Troubleshooting .....</b>	<b>77</b>
Checking if Wi-Fi is On and Connected.....	77
Turning Wi-Fi On and Connecting to a Network.....	77
Add Network Advanced (Connecting to a hidden network).....	78
Wi-Fi Testing.....	79
Wi-Fi Troubleshooting and Status Messages.....	79
<b>Legal Information .....</b>	<b>82</b>



# Safety Information

## READ ALL INSTRUCTIONS

For your own safety, the safety of others, and to prevent damage to the product and vehicles upon which it is used, it is important that all instructions and safety messages in this manual and the accompanying *Important Safety Instructions* manual be read and understood by all persons operating, or coming into contact with the product, before operating. We suggest you store a copy of each manual near the product in sight of the operator.

For your safety, read all instructions. Use your diagnostic tools only as described in the tool user's manual. Use only manufacturer recommended parts and accessories with your diagnostic tools.

This product is intended for use by properly trained and skilled professional automotive technicians. The safety messages presented throughout this manual and the accompanying *Important Safety Instructions* manual are reminders to the operator to exercise extreme care when using this product.

There are many variations in procedures, techniques, tools, and parts for servicing vehicles, as well as in the skill of the individual doing the work. Because of the vast number of test applications and variations in the products that can be tested with this instrument, we cannot possibly anticipate or provide advice or safety messages to cover every situation. It is the responsibility of the automotive technician to be knowledgeable of the system being tested. It is essential to use proper service methods and test procedures. It is important to perform tests in an appropriate and acceptable manner that does not endanger your safety, the safety of others in the work area, the equipment being used, or the vehicle being tested.

It is assumed that the operator has a thorough understanding of vehicle systems before using this product. Understanding of these system principles and operating theories is necessary for competent, safe and accurate use of this instrument.

Before using the equipment, always refer to and follow the safety messages and applicable test procedures provided by the manufacturer of the vehicle or equipment being tested. Use the product only as described in its user manual. Use only manufacturer recommended parts and accessories with your product.

Read, understand and follow all safety messages and instructions in this manual, the accompanying *Important Safety Instructions* manual, and on the test equipment.

Environmental Conditions:

- This product is intended for indoor use only
- This product is rated for Pollution Degree 2 (normal conditions)

## Safety Signal Words

All safety messages contain a safety signal word that indicates the level of the hazard. An icon, when present, gives a graphical description of the hazard. Safety Signal words are:



Indicates an imminently hazardous situation which, if not avoided, will result in death or serious injury to the operator or to bystanders.



Indicates a potentially hazardous situation which, if not avoided, could result in death or serious injury to the operator or to bystanders.



Indicates a potentially hazardous situation which, if not avoided, may result in moderate or minor injury to the operator or to bystanders.



## Safety Message Conventions

Safety messages are provided to help prevent personal injury and equipment damage. Safety messages communicate the hazard, hazard avoidance and possible consequences using three different type styles:

- Normal type states the hazard.
- **Bold** type states how to avoid the hazard.
- *Italic type states the possible consequences of not avoiding the hazard.*

An icon, when present, gives a graphical description of the potential hazard.

## Safety Message Example



Risk of electric shock.

- **Prior to recycling the battery pack, protect exposed terminals with heavy insulating tape to prevent shorting.**
- **Disconnect all test leads and turn diagnostic tools off before removing the battery pack.**
- **Do not attempt to disassemble the battery or remove any component projecting from or protecting the battery terminals.**
- **Do not expose the diagnostic tool or battery pack to rain, snow, or wet conditions.**
- **Do not short circuit the battery terminals.**

*Electric shock can cause injury.*

## Important Safety Instructions

For a complete list of safety messages, refer to the accompanying *Important Safety Instructions manual*.

**SAVE THESE INSTRUCTIONS**



# Customer Support / Links

North  
America

## Website

[diagnostics.snapon.com](http://diagnostics.snapon.com)

## User Manuals / Instructions

[snapon.com/diagnostics/us/UserManuals](http://snapon.com/diagnostics/us/UserManuals)

## Phone

1-800-424-7226

## E-Mail

[diagnostics\\_support@snapon.com](mailto:diagnostics_support@snapon.com)

## Online Contact Form

[snapon.com/diagnostics/us/Contact](http://snapon.com/diagnostics/us/Contact)

## Warranty Registration

United States

[registration.snapon.com/products/us](http://registration.snapon.com/products/us)

Canada

[registration.snapon.com/products/ca](http://registration.snapon.com/products/ca)

## ShopStream Connect™

[snapon.com/diagnostics/us/SSC](http://snapon.com/diagnostics/us/SSC)

## Snap-on® Cloud

[altusdrive.com](http://altusdrive.com)

## SureTrack® Community

Use [ShopKeyPro.com](http://ShopKeyPro.com), or [ProDemand.com](http://ProDemand.com)

SureTrack Login Info: [mitchell1.com/micro/stc/](http://mitchell1.com/micro/stc/)

## Secure Vehicle Gateway

[www.snapon.com/gateway](http://www.snapon.com/gateway)

## Training Solutions® Videos

[snapon.com/diagnostics/US/CC](http://snapon.com/diagnostics/US/CC)

## YouTube®

## ShopKey® Pro

[ShopKeyPro.com](http://ShopKeyPro.com)

## ProDemand®

[ProDemand.com](http://ProDemand.com)



## Quick Links

- [Specifications](#) page 1
- [Powering On/Off](#) page 2
- [Features and Buttons](#) page 3
- [Home Screen and Title Bar](#) page 4
- [Quick-Access Menu](#) page 5
- [Battery Pack](#) page 7
- [Care and Cleaning](#) page 10
- [Training Videos \(Online\)](#) page 11
- [Diagnostic Quick Tips - Video Series](#) page 10
- [Accessories](#) page 10

## 1.1 About This Manual

The information within this manual may be applicable to multiple markets. Not all the information included may be applicable to your diagnostic tool, device or product.

All content within this manual was based on the latest information available at the time of publishing and **applicable to diagnostic software version 20.4**. Some content within this manual may not be applicable to other diagnostic software versions.

The illustrations/pictures in this document are intended as reference only and may not depict actual screen results, information, functions or standard equipment.

All information, specifications and illustrations in this document are subject to change without notice.

The content in this manual is periodically revised to ensure the latest information is included. Download the latest version of this manual and other related technical documentation from the product website (see [Customer Support / Links](#) on page vi).

## 1.2 Serial Number / Software Version

The diagnostic tool serial number and software version can be viewed from: **Home: Tools > System Information** (see [System Information](#) on page 73).

The diagnostic tool serial number is also located on the back of the diagnostic tool housing.

## 1.3 Specifications

Item	Description / Specification
Touch Screen	Capacitive Touch Panel
Display	9.0 inch diagonal, TFT Color LCD
	1024 x 600 resolution WSVGA
Battery	Rechargeable lithium-ion battery pack
	Approximately 3 hour run time
	Approximately 5 hour charge time
Power Supply	Supply Rating; 15VDC, 2A
DC Operating Voltage	10 to 30VDC
Width	11.76 in. (298.7mm)
Height	6.38 in. (162.0mm)
Depth	1.57 in. (40.0mm)
Weight (including battery):	2.65 lb (1.20 kg)
Operating Temperature Range (ambient)	At 0 to 90% relative humidity (non-condensing) 32 to 113°F (0 to 45°C)
Storage Temperature (ambient)	At 0 to 70% relative humidity (non-condensing) -4 to 140°F (-20 to 60°C)
Operating Altitude	Maximum 2000 m
Environmental Conditions	This product is intended for indoor use only
	This product is rated for Pollution Degree 2 (normal conditions)



## 1.4 Powering On/Off

Press and release the **Power** button to turn on the tool.

Power may be supplied by any one of the following:

- Charged internal battery pack
- Live AC power supply (charging internal battery)
- The vehicle data link connector (DLC) (diagnostic tool data cable connected)

The tool will automatically turn on when:

- a live AC power supply is connected to the tool
- the Data Cable is connected to a vehicle data link connector

To turn off the tool, exit all functions and communication with the vehicle, then press and release the **Power** button. Follow the screen prompts to turn the tool off.

### **i** NOTE

*An optional power cable is required when testing non-OBD-II/EOBD or models that do not supply power on the DLC.*

### **IMPORTANT**

*Never connect the AC power supply adapter, or optional power cable to the diagnostic tool when communicating with a vehicle.*

### **IMPORTANT**

*All vehicle communication must be stopped **BEFORE** turning off the diagnostic tool. Never disconnect the Data Cable when the diagnostic tool is communicating with the vehicle.*

## 1.5 Emergency Shutdown

To force an emergency shutdown, press and hold the **Power** button for five seconds until the tool turns off.

Emergency shutdown should only be used if the diagnostic tool does not respond to navigation or control buttons or exhibits erratic operation.

### **IMPORTANT**

*On some vehicles, performing an emergency shutdown while communicating with the vehicle, may result in damage.*





## 1.6 Features and Buttons

### NOTE

Touch screen controls are used for most operations, however the control buttons may also be used to navigate and select functions.

Item	Description	
1	Power Supply Jack	
2	Battery Status Indicator LED	
3	Mini USB Jack	
4	Micro secure digital (uSD) Card - contains operating system programming. <b>IMPORTANT</b> The uSD card must be installed for operation. Do not remove the uSD card while the diagnostic tool is powered on.	
5	Data Cable Connector	
6	No / Cancel Button	
	Yes / Accept Button	
	Directional Control Buttons <i>Tip - These buttons can be used for general navigation, however are especially useful in certain situations where more control is needed, compared to using the touch screen.</i>	
	S (Shortcut) Button See <a href="#">Configure Shortcut Key</a> on page 73	
	Power (On/Off) Button	
7	Fold-out Stand	
8	Battery Pack Access	



Figure 1-1

# 1.7 Home Screen and Title Bar

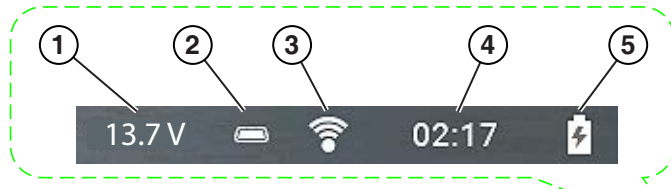

### Common Title Bar Indicators

- 1— Vehicle data link connector voltage
- 2— Active vehicle communication status
- 3— Wi-Fi connection status
- 4— Time of day
- 5— Battery charge level and power connection status

Figure 1-2

### Home Screen Icons (Links)

Scanner	
OBD-II/EODB	
Quick Lookups	
Previous Vehicles and Data	
Training and Support	
Tools	

## 1.8 Quick-Access Menu

Use the Quick-Access Menu as a shortcut to “jump” between functions, or to **Exit** the active vehicle. This menu is available within most functions (after identifying a vehicle), and is application sensitive, being that it provides only applicable links based on your location in the software.

The menu title displays the active vehicle identification information including the VIN.



Selecting the **Home** icon opens the **Quick-Access Menu**, depending on your location in the software.

Examples:

- Scanner to OBD-II/EOBD - to check monitor status or freeze frame data etc
- Scanner to Previous Vehicles and Data - to view a code scan report, screen shot, or captured PID data
- OBD-II/EOBD to Scanner - to check enhanced codes and access Intelligent Diagnostics
- Scanner to Exit Vehicle - to quickly end vehicle communication
- Scanner to Tools - to change display settings, turn Wi-Fi on, configure the Shortcut button or connect to a PC

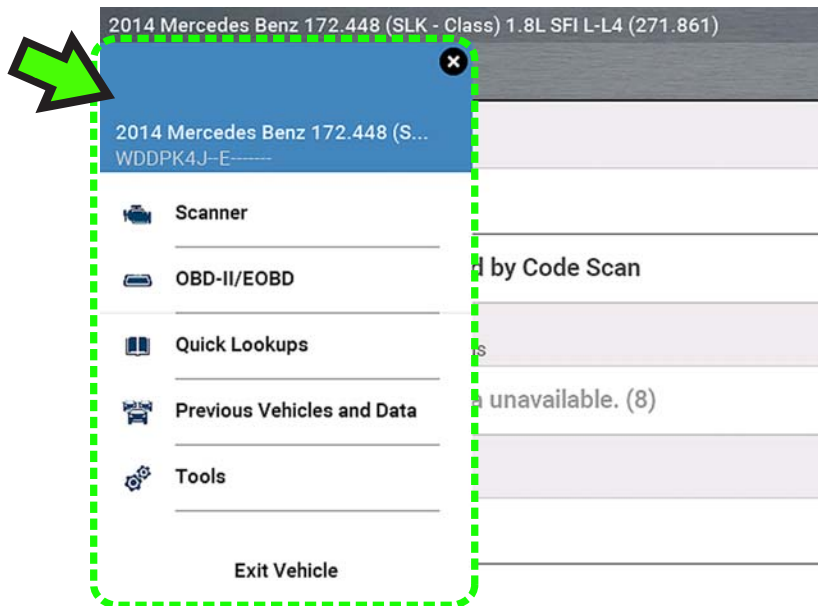

Figure 1-3

## 1.9 Printing Data and Screenshots

Use the Snap-on Cloud and ShopStream Connect to print data files and screenshots from the diagnostic tool. See [Snap-on Cloud](#) on page 12 and [ShopStream Connect™ \(Connecting to your PC\)](#) on page 13.

## 1.10 Scrolling (Navigation)

Onscreen scrolling controls are displayed (when applicable) to move screens up/down to view additional content. Scroll control icons display on the right-side of the screen, and may vary in appearance as shown in [Figure 1-4](#).

Multiple operation methods are:

- Touch the up/down arrow icons
- Swipe the screen up/down using your finger
- Use the up/down directional control buttons

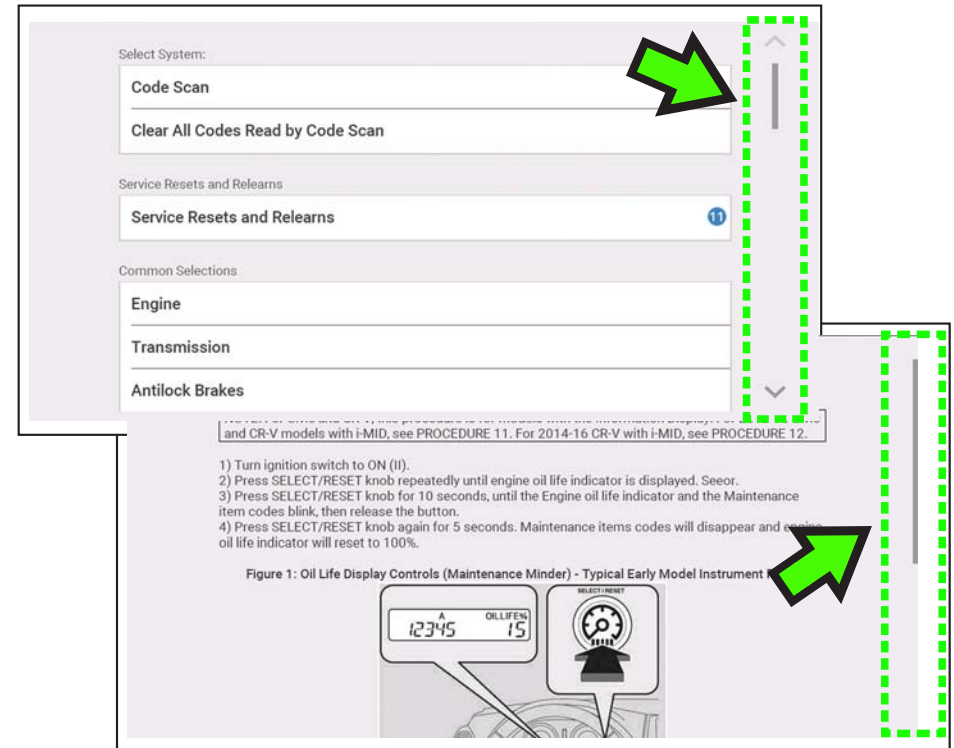



































Figure 1-4













## 1.11 Icon Reference Table

The following table includes only common icons, all icons are not shown.

Scanner (Common)			
	<b>Home</b> - Return to Home screen, or open Quick-Access menu		<b>Accept</b> - Accepts the highlighted selection
	<b>Next / Forward</b>		<b>Back / Last</b>
	<b>Save</b> - Saves the active information to memory.		<b>Automatic ID</b> - Automatically completes the identification process, once connected and make/year are entered.
	<b>Single Selection (List)</b> - Select / Deselect single item from list		<b>Multi-Selection (List)</b> - Select / Deselect all items in a list
	<b>Menu View</b> - Toggle between categorized / non-categorized list view		<b>Freeze Frame</b> - Display Freeze Frame data
	<b>Pause</b> - Pauses active data collection.		<b>Start (Capture)</b> - Resumes active data collection.
	<b>Clear</b> - Erases all the PID data in the buffer and restarts data collection.		<b>Custom Data List</b> - Allows you to choose which PIDs display.
	<b>Trigger</b> - Allows you to set, arm, and clear PID triggers		<b>Change View</b> - Toggle data display between list or graph.
	<b>Zoom</b> - Incrementally increases and decreases the scale of the data displayed.		<b>Lock</b> - Locks PIDs to the top of the list.

	<b>Step Forward</b> - Allows forward movement in singular steps. (Note: To quickly step forward during Scanner data review, press and hold )		<b>Step Back</b> - Allows backward movement in singular steps. (Note: To quickly step backward during Scanner data review, press and hold )
	<b>Skip Forward</b> - Allows forward movement in multiple steps.		<b>Skip Back</b> - Allows backward movement in multiple steps.
	<b>Help</b> - Opens the Getting Started with Intelligent Diagnostics slideshow.		<b>Diagnose</b> - Opens <a href="#">Intelligent Diagnostics</a> for the selected code.
	<b>PID Alarm</b> - Display visual indicators for two state PIDs		<b>Sort</b> - Toggles the alpha order of a list.
	<b>Data List Selector</b> - Choose data list during functional test		<b>Tools</b> - Change units of measure
Code Scan			
	<b>Refresh</b> - Restarts the code scan		<b>System</b> - Opens the main menu of the system selected
Oil Specs & Resets			
	<b>Fluid Capacity</b> - Displays OEM engine oil specifications and capacity information.		<b>Reset Procedure</b> - Displays OEM manual service indicator reset information.
	<b>Functional Reset</b> - Opens the Scanner service reset menu.	-	-
Tire and Wheel Service			

	Displays TPMS indicator reset instructions, to perform a manual reset of the TPMS indicator.		Opens the TPMS test related Scanner menu. Options may include, view and clear codes, display data, and access functional tests using the diagnostic tool.
	Displays TPMS service information.		Displays OEM tire and wheel specifications.
<b>Wi-Fi Icons</b>			
	Indicates Wi-Fi is ON and Connected		Indicates Wi-Fi is ON, Low Signal
	Wi-Fi On - Not Connected.		Opens Wi-Fi Test screen
<b>Previous Vehicles and Data Icons</b>			
	<b>Delete</b> - Deletes selected item (menu dependent)		<b>Search</b> - Lists associated vehicle attachments
	<b>Activate Vehicle</b> - Starts the vehicle identification process, of the selected vehicle		

## 1.12 Battery Pack

### 1.12.1 Safety

Follow all safety guidelines when handling the battery pack.



**WARNING**

**Risk of electric shock.**

- Prior to recycling the battery pack, protect exposed terminals with heavy insulating tape to prevent shorting.
- Disconnect all test leads and turn diagnostic tools off before removing the battery pack.
- Do not attempt to disassemble the battery or remove any component projecting from or protecting the battery terminals.
- Do not expose the diagnostic tool or battery pack to rain, snow, or wet conditions.
- Do not short circuit the battery terminals.

*Electric shock can cause injury.*



**WARNING**

**Risk of explosion.**

- The Lithium battery is factory replaceable only, incorrect replacement or tampering with the battery pack may cause an explosion.

*Explosion can cause death or serious injury.*

### IMPORTANT

***The battery pack contains no user serviceable components. Tampering with the battery pack terminals or housing will void the product warranty.***

Keep the following in mind when using and handling the battery pack:

- Do not short circuit battery pack terminals.
- Do not immerse the diagnostic tool or battery pack in water, or allow water to enter the diagnostic tool or battery pack.
- Do not crush, disassemble, or tamper with the battery pack.
- Do not heat the battery pack to over 100°C (212°F), or dispose of it in a fire.
- Do not expose the battery pack to excessive physical shock or vibration.

- Keep the battery pack out of reach of children.
- Do not use a battery pack that appears to have suffered abuse or damage.
- Charge the battery pack in the appropriate charger only.
- Do not use a battery charger that has been modified or damaged.
- Use the battery pack for the specified product only.
- Store the battery pack in a cool, dry, well ventilated area.

### **i** NOTE

*The battery pack should be used within a short period of time (about 30 days) after charging to prevent loss of capacity due to self-discharging.*

If long-term storage of the battery pack is necessary, it should be stored in a cool, dry, well ventilated place with a 30 to 75 percent state of charge to prevent loss of characteristics.

To prolong the life of your battery, turn off the diagnostic tool when not in use. The diagnostic tool has a built in charger that recharges the battery on demand whenever it is connected to a power source.

## 1.12.2 Removal / Installation

### IMPORTANT

**Only use the manufacturer recommended original equipment replacement battery pack.**

#### **▶** REMOVAL (Figure 1-5)

1. Loosen the battery cover screw on the back-side of the diagnostic tool.
2. Pull up and out on the lower edge of the battery cover to release it.
3. Remove the battery pack in the same manner as the battery cover, pulling the bottom edge up and tilting out.

#### **▶** INSTALLATION (Figure 1-5)

1. Position the battery pack as shown below with the arrows facing up.
2. Tilt the top of the battery in to align the tabs, then down to install into place.
3. Install the battery pack cover, in the opposite manner as removal, aligning the tabs and tilting down and in, into place.
4. Tighten the battery cover screw. **Do not overtighten the screw!**

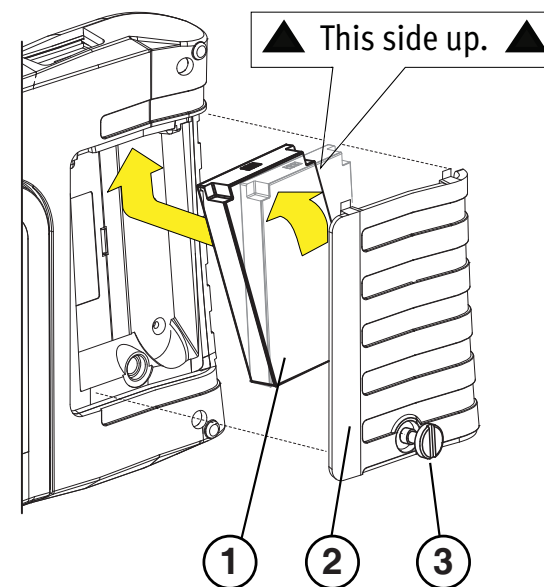

- 1— Battery Pack
- 2— Cover
- 3— Cover Screw

Figure 1-5

## 1.12.3 Charging

The diagnostic tool can be powered from the internal rechargeable battery pack. A fully charged battery pack provides sufficient power for about 3 hours of continuous operation. For battery pack removal and installation instructions see, [Removal / Installation on page 8](#).



Battery charging occurs whenever the data cable is connected to a vehicle DLC. Battery charging also occurs when the AC power supply is connected to a live AC power source, and connected to the diagnostic tool. Use the supplied AC power supply to charge the battery pack.



Insert the end of the AC power supply cable into the diagnostic tool power supply jack, then connect the AC power supply to an approved AC power source.

**IMPORTANT**

**Only use the supplied AC power supply. Never connect the power supply to the diagnostic tool when the tool is communicating with a vehicle.**

The Battery Status Indicator LED (located next to the power supply jack) indicates battery status.

Battery Status LED (Top of Tool)	
	<b>Green</b> - Fully charged / power supplied by the AC power supply.
	<b>Red</b> - Charging
	<b>Amber</b> - Fault Mode, battery temperature above 104°F/ 40°C. Allow the tool and battery to cool down before continuing operation.

Battery Charge Status Indicator (Title Bar)	
	<b>Full Battery Charge Level</b> - Indicates power is being supplied by the internal battery pack. Horizontal bars diminish as the battery discharges.
	<b>Low Battery Charge Level</b> - Indicates the internal battery pack is low and needs to be recharged immediately. A warning message will also display on the screen when the battery gets low.
	<b>External Power Connected</b> - Indicates power is being supplied through the data cable connection to a vehicle or by the AC Power Supply and charging the battery pack.

**1.12.4 Ordering a Replacement**

If the battery pack needs to be replaced, contact your sales representative to order a new battery pack.

**IMPORTANT**

**Only use the manufacturer recommended original equipment replacement battery pack.**

**1.12.5 Disposal (North America)**

Always dispose of the battery pack according to local regulations, which vary for different countries and regions. The battery pack, while non-hazardous waste, does contain recyclable materials. If shipping is required, ship the battery pack to a recycling facility in accordance with local, national, and international regulations.

**IMPORTANT**

**Always dispose of materials according to local regulations.**

For additional information within the **United States of America** contact:

- Rechargeable Battery Recycling Corporation (RBRC) at [www.call2recycle.org](http://www.call2recycle.org)  
Phone - 800 822-8837

For additional information within **Canada** contact:

- Rechargeable Battery Recycling Corporation (RBRC) at [www.call2recycle.ca](http://www.call2recycle.ca)  
Phone - 888 224 9764

Products bearing the WEEE logo (*Figure 1-6*) are subject to European Union regulations.



Figure 1-6

Contact your sales representative for details.



## 1.13 Care and Cleaning

Periodically perform the following tasks to keep your diagnostic tool in proper working order:

- Check the housing, cables and connectors for dirt and damage before and after each use.
- At the end of each work day, wipe the diagnostic tool housing, cables and connectors clean with a water damped soft cloth.

Clean the touch screen and housing using mild soap and a water damped soft cloth.

### IMPORTANT

***Do not use any abrasive cleansers or automotive chemicals on the touch screen or housing.***

## 1.14 Accessories

Find diagnostic tool accessories using our Interactive Accessories Catalog:

visit <http://diagnostics.snapon.com> and enter “accessories catalog” in the Search field.

Additional accessory information is located in our Vehicle Application Guide:

visit <http://diagnostics.snapon.com> and enter “application guide” in the Search field.

Contact your sales representative to purchase product accessories.

## 1.15 Diagnostic Quick Tips - Video Series

Snap-on Diagnostic Quick Tips videos are available at no charge on our website and on our YouTube channel. These videos are developed from real repair case studies to help professional technicians use diagnostic tools to solve specific vehicle problems (e.g. performing a Ford Relative Injector Flow Test).

Additional videos are also available showing specific diagnostic tool features (e.g. ShopStream Connect - Software Updates).



Figure 1-7

Videos are available at:

<http://diagnostics.snapon.com> - Click on the “Training & Support” tab, select the applicable diagnostic tool, then select “See Quick Tips”

<https://www.youtube.com/user/snaponscanner/videos> - Use the search function to find a title, or enter “Diagnostic Quick Tips” in the search field to see a list of all applicable titles.

### NOTES

*URL links (above) and titles listed (below) are subject to change and may not be available in all markets.*

*A sample list of titles are listed below, other titles may be available.*

Some videos may not applicable for use with all diagnostic tools.

#### Snap-on® Training Solutions® - Diagnostic Quick Tips Videos (examples)

Air/Fuel Ratio Sensor Test	Fuel Injector Voltage and Current Tests (Scope)
Alternator Ripple Test (Scope)	Fuel Pump Current Ramp Test (Scope)
BMW® Rain Sensor Calibration	Harley-Davidson® ABS Brake Bleed





Snap-on® Training Solutions® - Diagnostic Quick Tips Videos (examples)	
CAN Bus Diagnostics (Scope)	Harley-Davidson® Functional Tests
Chevrolet® Volt Coolant Pump Bleed	Harley-Davidson® Key Fob Programming
Chrysler HVAC Test	Hyundai Blind Spot Detection System Calibration
Chrysler VVT System Cleaning	Hyundai Occupant Detection System Reset
Chrysler Wheel & Tire Calibrations	Ignition Coil Current and Voltage Comparison
COP Ignition Test	Ignition Coil Current Ramp Test
Dual Screen Diagnostics: Scanner vs. Scope	Ignition Coil Primary Voltage Test
Electronic Throttle Control System Diagnostics	Ignition System Diagnostics Using the SIA2000 (Scope)
FIAT® 500 Proxi Alignment	MINI Battery Relearn
FIAT® 500 Throttle Body Relearn	Multi Channel Cam / Crank Correlation
Flex Ray Bus Diagnostics	OBD-II Mode 10 Permanent Codes
Ford Battery Monitor System	Oil Specs & Service Light Resets
Ford Coil Current RFI Test (Scope)	PID Trigger Functions (Scanner)
Ford Flash Reprogramming	Piezo Injectors Signature Test
Ford Misfire Monitor Neutral Profile Correction (Scanner)	Relative Compression Test (Scope)
Ford PATS Key Programming	ShopStream Connect - Data Manipulation
Ford Relative Compression Test	ShopStream Connect - Software Updates
Ford Relative Injector Flow Test	Speed Up Your Diagnostics (Scanner)
Ford TPMS Reprogramming	The Power of Troubleshooter Tips (Scanner)
Ford® 6.7L Transmission Solenoid Characterization	Top Level Menus: Built In Scope Training
Ford® Diesel Injector Coding	Toyota EVAP Test
VW / Audi Flexible Service Reset (Scanner)	Toyota Multiple Freeze Frame (Scanner)
	Toyota Transmission Compensation Coding

## 1.16 Training Videos (Online)

Diagnostic tool specific training videos are available on our website (see [Customer Support / Links on page vi](#)). Follow along and learn the basics of diagnostic tool operation with our free training videos.

*Sample titles are listed below. Not all titles may be available for all diagnostic tools, and are subject to change.*

Snap-on® Training Solutions® - Training Videos (examples)	
Introduction and Navigation	Global OBD-II
Scanner Codes	Digital Multimeter
Scanner Data in PID View	Graphing Multimeter & Lab Scope
Scanner Data in Graphing View	Guided Component Tests
Fast-Track® Troubleshooter	Vehicle Specs & Resets
Functional Tests	SureTrack® & Wi-Fi

This section is intended as an introduction to the following applications that are available as a companion to your diagnostic tool. These applications may require you to have the current diagnostic software version installed, application authorization and additional setup information. For additional information, see the respective user manual / instructions on the product website (see [Customer Support / Links on page vi](#)).

## 2.1 Snap-on Cloud



For more information on the features and operation of the Snap-on Cloud, see the **Snap-on Cloud User's Guide** on the website, and visit [ALTUSDRIVE.com](http://ALTUSDRIVE.com)

### NOTE

**Wi-Fi Required** - Wi-Fi connection is required to use this application. See [Wi-Fi Connection / Troubleshooting](#) on page 77.

The Snap-on Cloud is a free mobile-friendly cloud-based application designed specifically for technicians to store, organize and share information. Typical screens shown in ([Figure 2-1](#) and [Figure 2-2](#)).

#### Key Features:

- Diagnostic tool automatically transfers code scan reports, ADAS reports and screen captures to the Snap-on Cloud.
- Access and manage your Snap-on Cloud account, using your mobile device or PC.
- Share/send files via e-mail, or other mobile apps.
- Tag files (attach a descriptive key-name) to help you organize and search files.

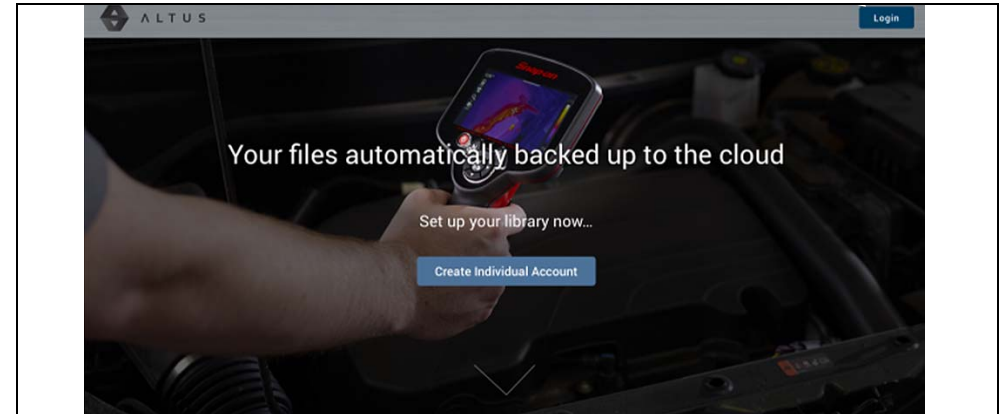

Figure 2-1

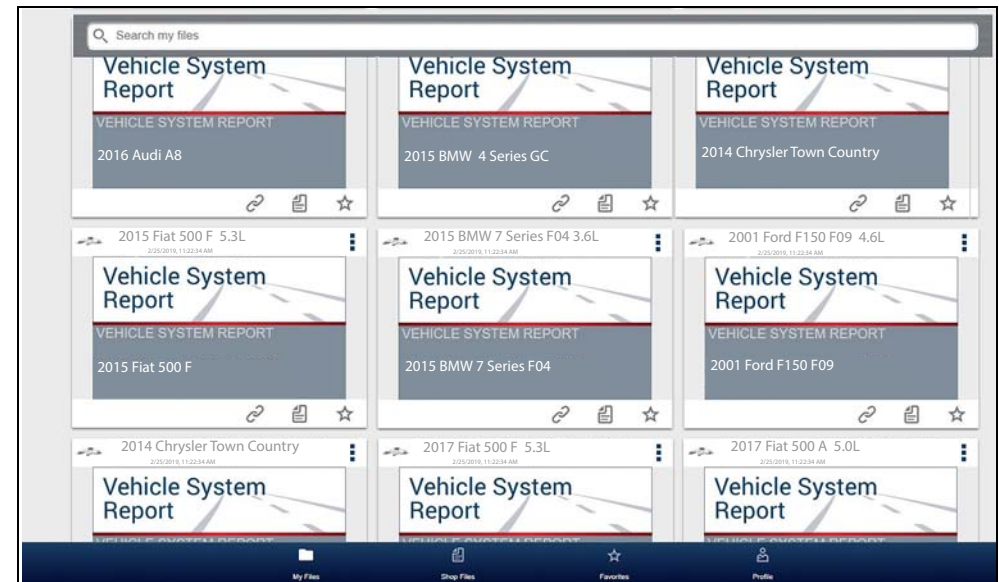

Figure 2-2



## 2.1.1 Authorization Codes

### Navigation

Home Screen: **Tools > Get Connected**

The authorization codes needed to register and use the Snap-on Cloud are located on the Get Connected screen ([Figure 2-3](#)).

### **i** NOTE

*It is normal operation for the PIN codes to change every time the page is refreshed.*

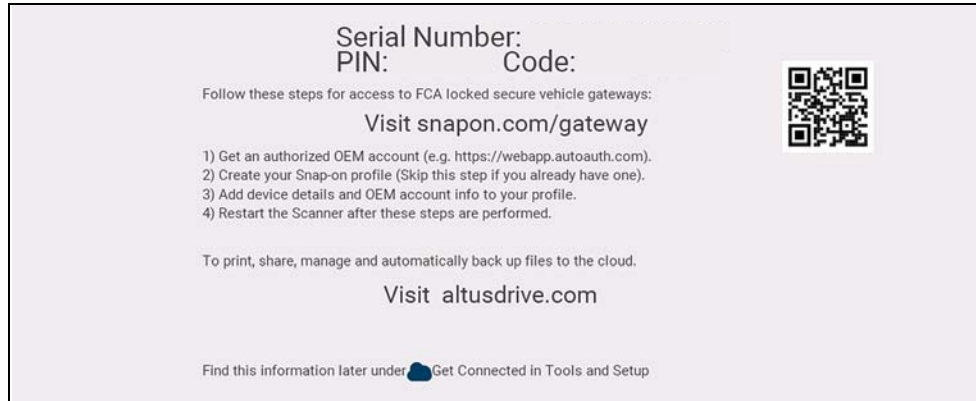

Figure 2-3

## 2.2 ShopStream Connect™ (Connecting to your PC)

For more information on ShopStream Connect, see the **ShopStream Connect User's Guide** on the product website (see [Customer Support / Links](#) on page vi).

### **i** NOTE

*This application requires USB connection of the diagnostic tool to a personal computer with Internet access.*

ShopStream Connect is a free PC application that allows you to:

- Transfer, print and edit (select fields) the (Code Scan) Vehicle System Report
- Transfer and print data files, and screenshots
- View, save and manage data files on your PC.
- Add or edit notes and comments to your data files.

### To Get ShopStream Connect (SSC):

1. Download and install SSC on your PC from:  
(see ShopStream Connect link on [Customer Support / Links](#) on page vi)
2. Connect the supplied USB cable from the USB jack on your diagnostic tool to your PC:
3. From the Home screen on the tool, select **Tools > Connect-to-PC**.

Once connected ShopStream Connect will open automatically on your PC.

Typical screens shown in ([Figure 2-4](#) and [Figure 2-5](#)).

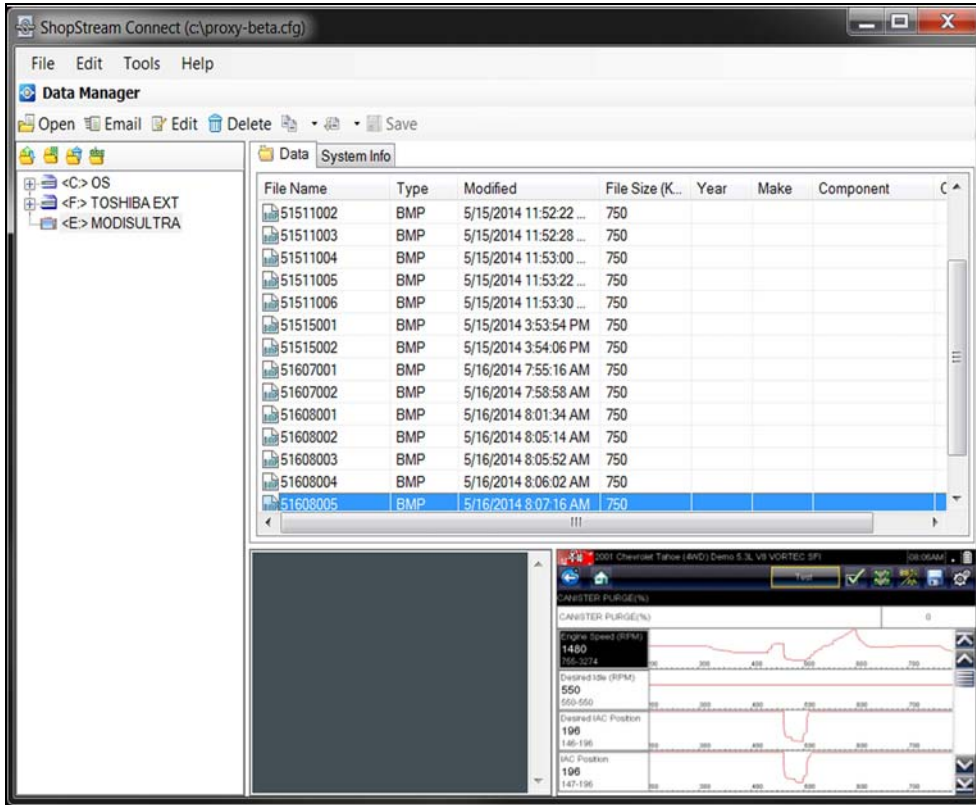

Figure 2-4

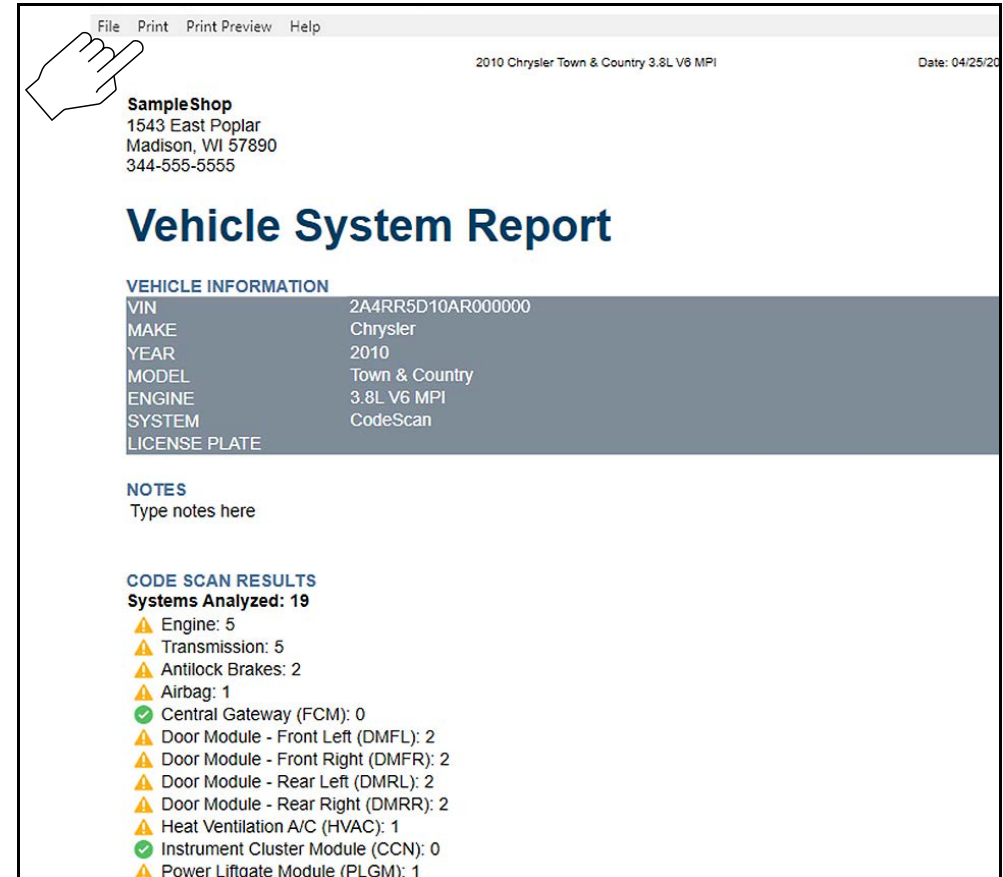

Figure 2-5



## 2.3 SureTrack® (On PC)

For more information on SureTrack, see the **Suretrack User's Guide** on the product website (see [Customer Support / Links](#) on page vi).

### **i** NOTE

*This application requires Internet access, via computer or mobile device.*

Your diagnostic tool may include authorization to access to the online SureTrack Community. You can use your PC to access the latest Real Fixes, Related Tips, and Common Repair Procedures information.

SureTrack is an evolving database of "real-world" automotive repair knowledge based on expert knowledge and millions of actual repair orders.

Typical login screen shown in ([Figure 2-6](#)).

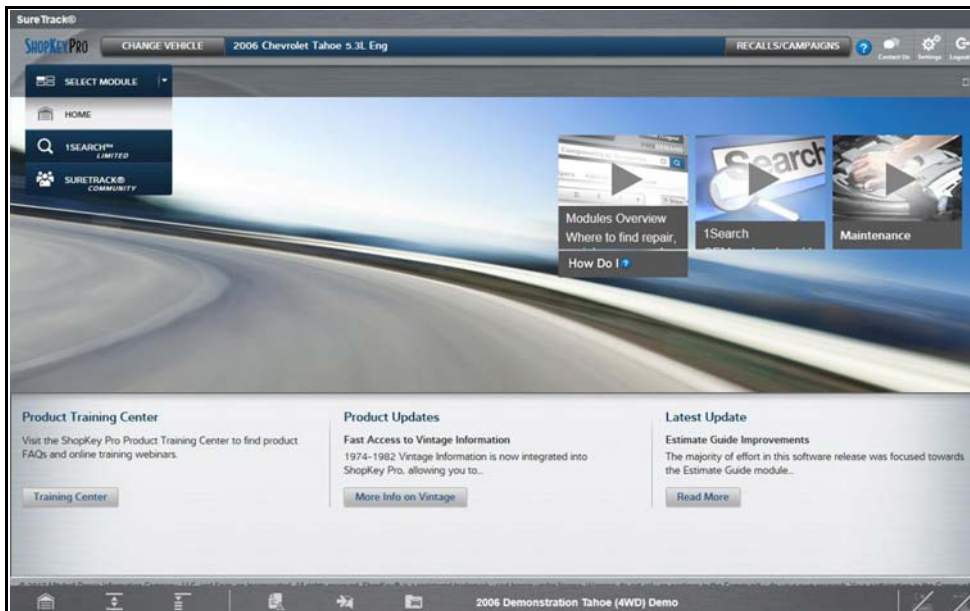

Figure 2-6



### 3.1 About Ethernet Equipped Vehicles and Data Cables

Automotive Ethernet can be thought of, as the physical networking architecture used to allow multiple vehicle controllers and components to communicate. Ethernet can transport data 100 times faster than CAN and is better suited for the needs of modern safety systems. Just as CAN Bus communications are monitored via the OBD-II diagnostic link connector, Ethernet Bus communications can be monitored in the same way.

Ethernet equipped vehicles use the standard 16 pin OBD-II diagnostic link connector for diagnostic tool connection, however the diagnostic tool data cable must be designed to support Ethernet communication.

This diagnostic tool has the ability to communicate with Ethernet equipped vehicles. In order to communicate via Ethernet, the data cable supplied with this tool (marked "DA-4E") must be used. Substituting a different data cable may result in no or an erroneous communication condition.

### 3.2 Data Cable Connection (OBD-II/EOBD Vehicles)

#### IMPORTANT

**Only use the supplied data cable, and/or original equipment accessory cables with your diagnostic tool. Total data cable length must not exceed 114.17 inches (2.9 meters).**

#### NOTE

*The diagnostic tool will automatically turn on when the Data Cable is connected to a vehicle that has 12VDC at the data link connector (DLC). An LED indicator on the DLC end of the data cable illuminates when power is being supplied. If the LED fails to illuminate, check the data cable connection and then the DLC power circuit.*

1. For OBD-II/EOBD compliant vehicles, connect the DA-4E data cable (26 pin end) to the diagnostic tool ([Figure 3-1](#)). Connect the cable with the arrow facing up (display side).

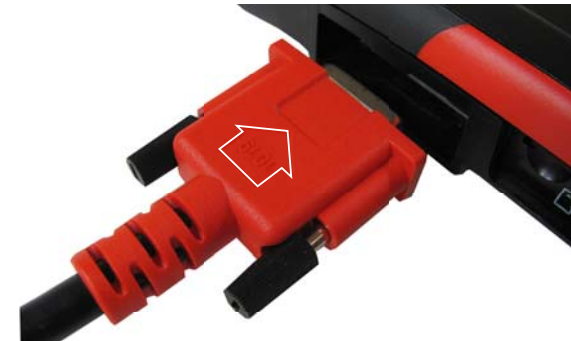

Figure 3-1 Arrow highlighted for illustration purposes only.



The supplied data cable, includes an LED flashlight on the vehicle DLC connector end (*Figure 3-2*). The LED flashlight is powered by the diagnostic tool battery, and is useful when locating the vehicle DLC.

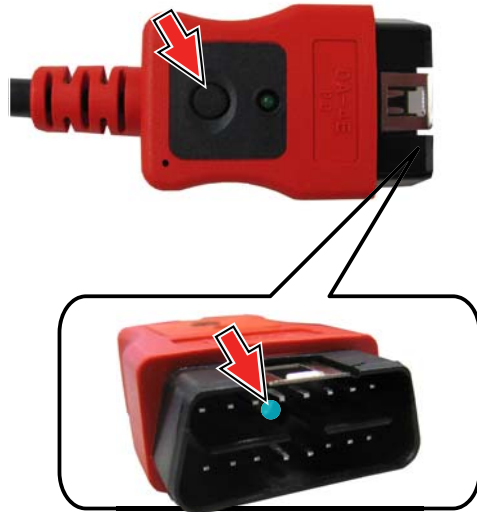

Figure 3-2

2. Connect the 16-pin (J-1962) end of DA-4E cable (*Figure 3-3*) to the vehicle DLC.



Figure 3-3

### **i** NOTE

*During vehicle identification, on-screen cable connection instructions may be provided along with the location of the DLC.*

### 3.3 Data Cable Connection (OBD-I Vehicles)

For most OBD-I (non-OBD-II/EOBD) compliant vehicles you can use the supplied data cable with the optional DA-5 adapter, and an optional manufacturer specific OBD-I adapter (Figure 3-4).

- The 26-pin end "A" of the cable (Figure 3-4) connects to the diagnostic tool.
- The 16-pin end "B" of the cable (Figure 3-4) connects to the DA-5 adapter "C".
- One end of the manufacturer specific adapter "D" (Figure 3-4) connects to the DA-5 adapter.
- The other end of the manufacturer specific adapter "E" (Figure 3-4) connects to the vehicle.

OBD-I adapters with a power jack MUST be connected to the vehicle battery using an accessory power cable "F" (Figure 3-4). See Figure 3-5 for additional information.

If the OBD-I adapter does not have a power jack, an external power connection (accessory power cable) is not needed.

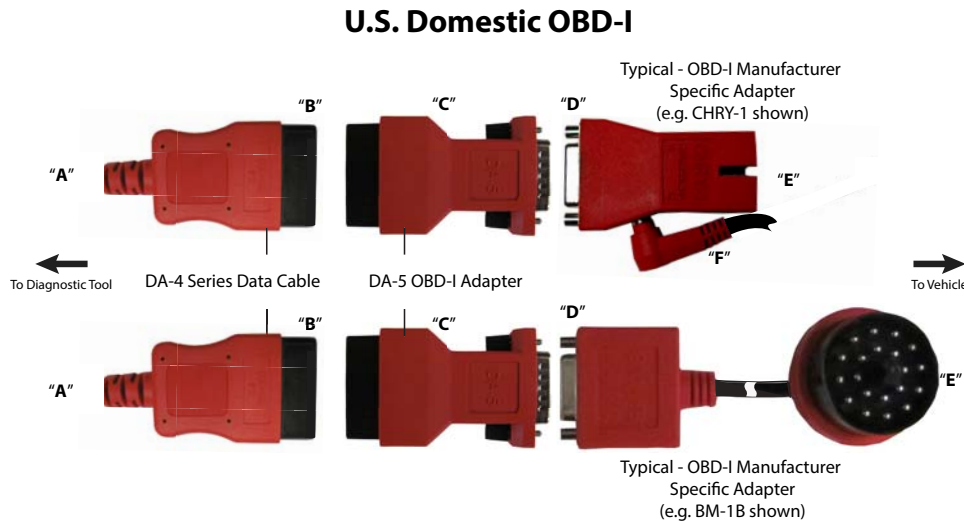

Figure 3-4

Figure 3-5 shows a typical OBD-I adapter (with power jack). This type of adapter MUST be connected to the vehicle battery, using either of the power cables shown.

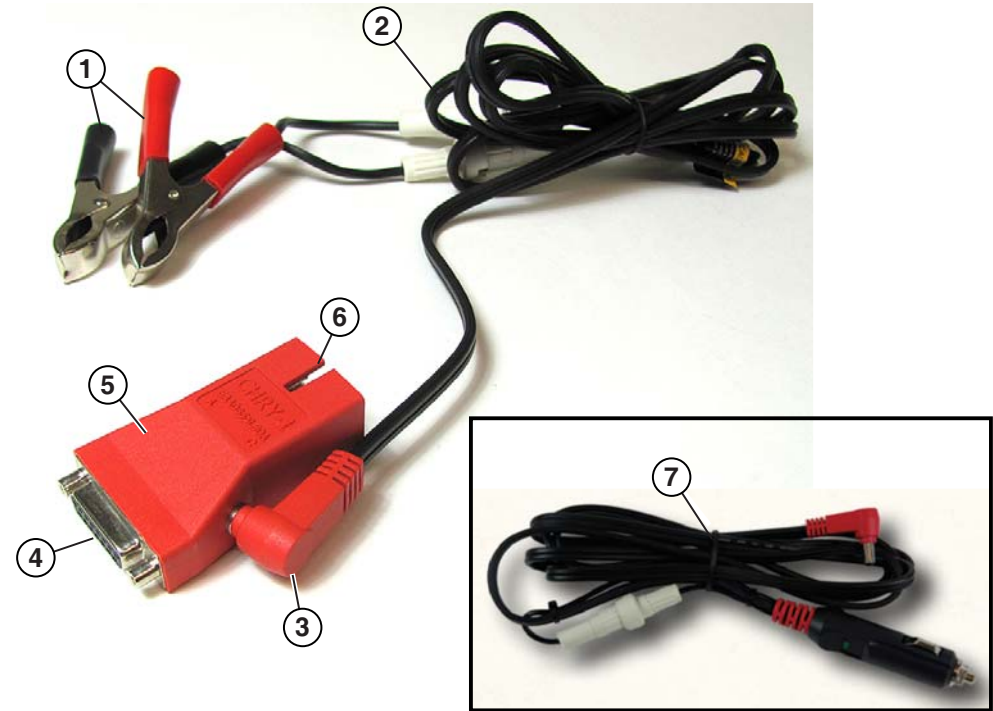

Figure 3-5

- 1— Connect Clamps to Vehicle Battery
- 2— Accessory Power Cable (Battery clamp type)
- 3— Power Cable Connection
- 4— Connects to DA-5 Adapter
- 5— Typical OBD-I Adapter (with power jack)
- 6— Connects to Vehicle
- 7— Accessory Power Cable (Power port type)

**NOTE**

Only use original Snap-on data cables and accessories with your diagnostic tool. Total data cable length must not exceed 114.17 inches (2.9 meters).





### 3.3.1 Optional OBD-I Data Cables and Adapters

- An optional **OBD-I data cable adapter (DA-5)** is available, which allows connection of the supplied DA-4E (OBD-II/EOBD) cable to the DA-5 adapter. The DA-5 adapter connects to the manufacturer specific OBD-I adapter. This may be used instead of the optional OBD-I data cable.
- An optional **OBD-I data cable** is available, which allows direct connection between the diagnostic tool and the manufacturer specific OBD-I adapter. This may be used instead of the optional DA-5 adapter.
- An optional **U.S. domestic and Asian vehicle OBD-I adapter kit** is available for select vehicles. The kit includes multiple manufacturer specific adapters and cables for OBD-I connection.
- An optional **European vehicle OBD-I adapter kit** is available for select vehicles. The kit includes multiple manufacturer specific adapters, cables and personality keys, providing OBD-I connection capabilities for select vehicles such as Mercedes Benz, VW and BMW. Depending on your diagnostic tool, optional European vehicle software may be required.

Contact your sales representative to purchase all optional accessories and software.



The Scanner function allows your diagnostic tool to communicate with the electronic control modules (ECMs) of a vehicle. This allows you to perform tests, view diagnostic trouble codes (DTCs), and data parameters from various vehicle systems such as the engine, transmission, antilock brake system (ABS) and more.

### NOTE

Scanner functionality, feature availability, navigation and terminology is vehicle manufacturer dependent, and will vary.













## 4.1 Quick Links

- [Basic Operations](#) page 22
- [Scanner Control Icons](#) page 20
- [Secured Vehicle Gateway](#) page 21
- [Quick-Access Menu](#) page 21
- [Vehicle Voltage Readout](#) page 21
- [Scanner Overview](#) page 22
- [Vehicle Identification](#) page 22
- [Working with Trouble Codes](#) page 25
- [Codes Menu](#) page 25
- [Code Scan](#) page 25
- [Service Resets and Relearns](#) page 27
- [Working with Data \(PIDs\)](#) page 28
- [Data Menu](#) page 28
- [Custom Data Lists](#) page 28
- [Pausing and Reviewing Active Data](#) page 32
- [Using Zoom](#) page 34
- [Using Triggers](#) page 35
- [Functional Tests](#) page 38
- [Troubleshooter](#) page 38

## 4.2 General Information

### 4.2.1 Scanner Control Icons

Icon	Function	Icon	Function
	<b>Pause</b> - Pauses active data collection.		<b>Start (Capture)</b> - Resumes active data collection.
	<b>Clear</b> - Erases all the PID data in the buffer and restarts data collection.		<b>Custom Data List</b> - Allows you to choose which PIDs display.
	<b>Trigger</b> - Allows you to set, arm, and clear PID triggers		<b>Change View</b> - Toggle data display between list or graph.
	<b>Zoom</b> - Incrementally increases and decreases the scale of the data displayed.		<b>Lock</b> - Locks PIDs to the top of the list.
	<b>Step Forward</b> - Allows forward movement in singular steps. (Note: To quickly step forward during Scanner data review, press and hold )		<b>Sort</b> - Toggles the alpha order of a list.
	<b>Skip Forward</b> - Allows forward movement in multiple steps.		<b>Step Back</b> - Allows backward movement in singular steps. (Note: To quickly step backward during Scanner data review, press and hold )
	<b>Help</b> - Opens the Getting Started with Intelligent Diagnostics slideshow.		<b>Skip Back</b> - Allows backward movement in multiple steps.

Icon	Function	Icon	Function
	<b>Diagnose</b> - Opens <a href="#">Intelligent Diagnostics</a> for the selected code.		<b>Save</b> - Saves the active information to memory.
	<b>Automatic ID</b> - Automatically completes the identification process, once connected and make/year are entered.		<b>PID Alarm</b> - Display visual indicators for two state PIDs
	<b>Single Selection (List)</b> - Select / Deselect single item from list		<b>Multi-Selection (List)</b> - Select / Deselect all items in a list
	<b>Next / Forward</b>		<b>Back / Last</b>
	<b>Menu View</b> - Toggle between categorized / non-categorized list view		<b>Freeze Frame</b> - Display Freeze Frame data
	<b>Data List Selector</b> - Choose data list during functional test		<b>Tools</b> - Change units of measure

## 4.2.2 Secured Vehicle Gateway

To protect against unauthorized vehicle network manipulation, many automobile manufacturers now **require special authorization** to allow the scan tool to communicate with select vehicle modules.

To learn more about how to connect this diagnostic tool to vehicles using a secured gateway. See [Customer Support / Links on page vi](#) for Secure Vehicle Gateway website link.

## 4.2.3 Quick-Access Menu

Selecting the **Home** icon opens the Quick-Access menu, depending on your location in the software. Use this feature as a shortcut to “jump” between functions, or to **Exit** the active vehicle. For additional information see [Quick-Access Menu on page 5](#).

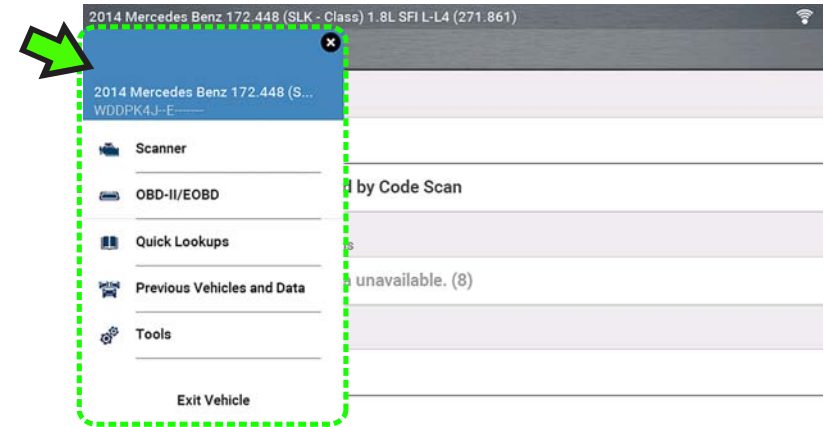

Figure 4-1

## 4.2.4 Vehicle Voltage Readout

When the data cable is connected to the vehicle, the vehicle's battery voltage (at the data link connector) is displayed on the top of the screen.

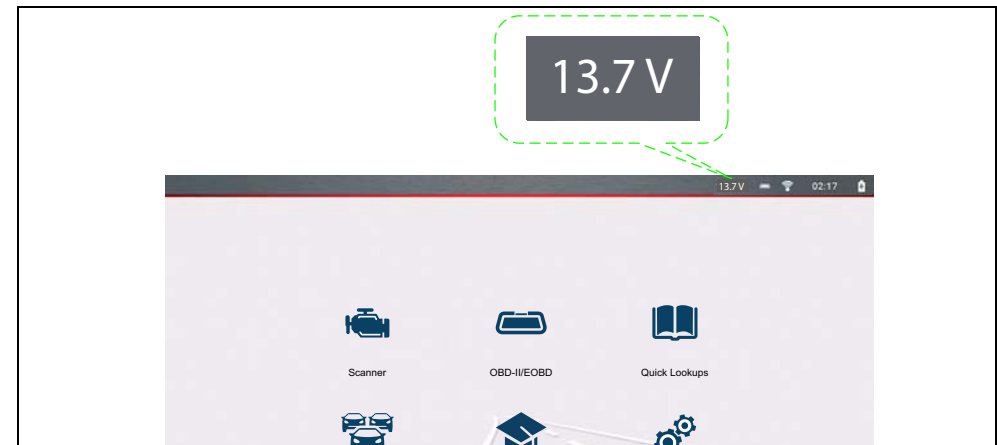

Figure 4-2



## 4.3 Basic Operations

### 4.3.1 Scanner Overview

#### Navigation

##### Home Screen: **Scanner**

1. Turn the vehicle ignition switch on.
2. Connect the data cable to the tool and vehicle. See [Data Cable / Connections on page 16](#)

The diagnostic tool will turn on automatically when connected to an OBD-II vehicle.

Depending on the vehicle, Instant ID may occur and the identification process automatically starts. See [Instant ID on page 23](#) for additional information.

If Instant ID is not supported, select **Scanner** and follow the screen prompts to identify the vehicle. See [Vehicle Identification on page 22](#) for additional information.

#### **i** NOTE

*Menus, options and procedures may vary by vehicle. Not all vehicles support the Auto ID and, or Instant ID feature.*

3. Select a **Vehicle System** (e.g. Engine, Transmission).
4. Select a **Vehicle System Test/Function** (e.g. Codes Menu) to perform. See [System and Test Selection on page 24](#).

#### IMPORTANT

**To avoid damage to the vehicle electronic control modules, never disconnect the data cable or disrupt the power supply during Scanner vehicle communication. Exit tests and stop Scanner vehicle communication before disconnecting the data cable or powering down the diagnostic tool.**

5. To exit Scanner vehicle communication, select the **Home** icon then select **Exit Vehicle** from the Quick-Access menu.

### 4.3.2 Vehicle Identification

#### **i** NOTE

*Menus, options and procedures vary by vehicle. Not all vehicles support Auto ID and, or Instant ID.*

Depending on the vehicle, the vehicle identification process may require manual entry of the vehicle information, or it may be automated. The following functions are available to identify the vehicle:

**Instant ID** - See [Instant ID on page 23](#) for additional information.

**Manual ID** - Allows for manual entry of all required vehicle identification criteria, see [Manual ID on page 22](#).

**Auto ID** - Automatically completes the identification process after the vehicle make and year are manually entered. see [Manual ID on page 22](#).

**OBDII/EOBD ID** - See [Alternative Vehicle Identification on page 23](#) for additional information.

#### Manual ID

1. Turn the vehicle ignition switch on.
2. Connect the data cable to the tool and vehicle. See [Data Cable / Connections on page 16](#).
3. If required, turn the diagnostic tool on (the tool should automatically turn on when connected to the vehicle).
4. Select **Scanner** from the Home screen.
5. Follow the screen prompts to enter the vehicle make and year.
6. If prompted select, **Automatic ID** or **Manual ID**.



Selecting **Automatic ID** or the **Automatic ID icon** will start the automatic vehicle identification process.

Selecting **Manual ID** will allow you to continue manually identifying the vehicle.

7. Follow the screen prompts to complete the vehicle identification process .
8. The vehicle identification confirmation screen displays ([Figure 4-3](#)), select **Ok** to continue.

**NOTE**

Data cable location and connection information may be provided.

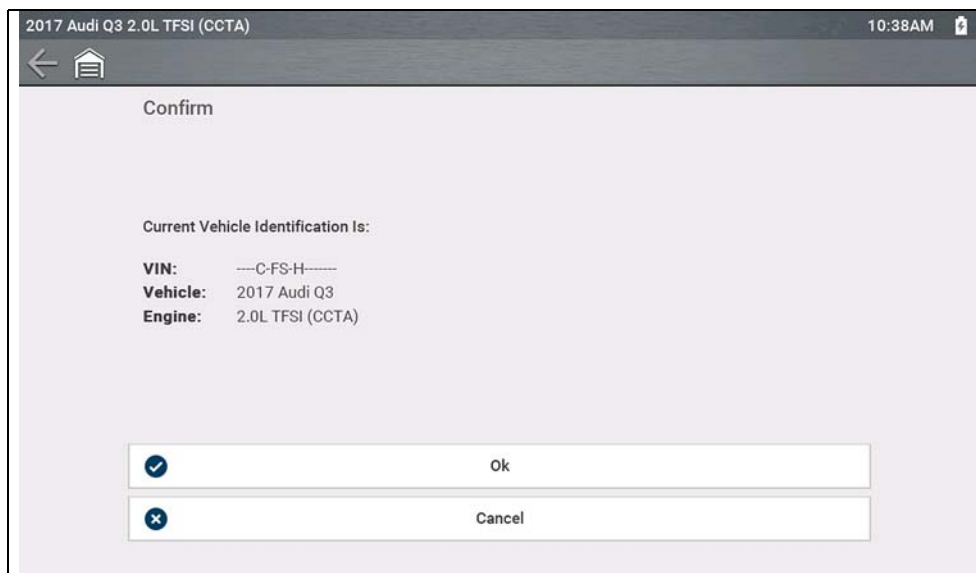

Figure 4-3

**Instant ID**

Instant ID automatically communicates with the vehicle to start the vehicle identification process.

**Operational Requirements:**

- **Vehicle requirements:**
  - Vehicle must support Mode \$09 VIN.
  - **Note:** Mode \$09 VIN is mandated on 2008 and newer vehicles.
  - Vehicle must be equipped with Hi Speed CAN or J1850 communication protocol.
- **Connection procedure requirements:**
  1. Turn vehicle ignition on.
  2. Connect data cable to the tool and then the vehicle.  
An audible "beep" will sound approximately 6 seconds after boot-up, if the VIN is read.
  3. Vehicle identification confirmation displays, select **Ok** to continue.

**NOTE**

If the Scanner feature is exited during the session that Instant ID was used, selecting Scanner again, will not ID the vehicle again. To quickly ID the vehicle again, select it from **Previous Vehicles and Data > Vehicle History**.

**Alternative Vehicle Identification**

If you try to identify a vehicle that the Scanner does not recognize, you can try and establish communication by using the **OBDII/EOBD** function, see [OBD-II/EOBD](#) on page 63. Communication is limited to basic OBD-II or EOBD diagnostic functions.

### 4.3.3 System and Test Selection

#### Navigation

**Home Screen:** [Typical] Scanner (Vehicle Identification) > (Vehicle System Menu)

After the vehicle is identified, a menu of available systems and/or test options is displayed (*Figure 4-4*).



Use the **Menu View** icon (*Figure 4-4*) to toggle between a categorized and non-categorized list view.

Select a system/test option as applicable.

#### **i** NOTE

*Only the systems/ test options supported for the vehicle are displayed.*



Figure 4-4

Once a system/test option is selected, the available options for that system are displayed in the System Main Menu (*Figure 4-5*).

#### Navigation

**Home Screen:** [Typical] Scanner (Vehicle Identification) > (Vehicle System Menu) > (Vehicle System Main Menu)

See *Working with Trouble Codes* on page 25 for descriptions of typical System Main Menu options.

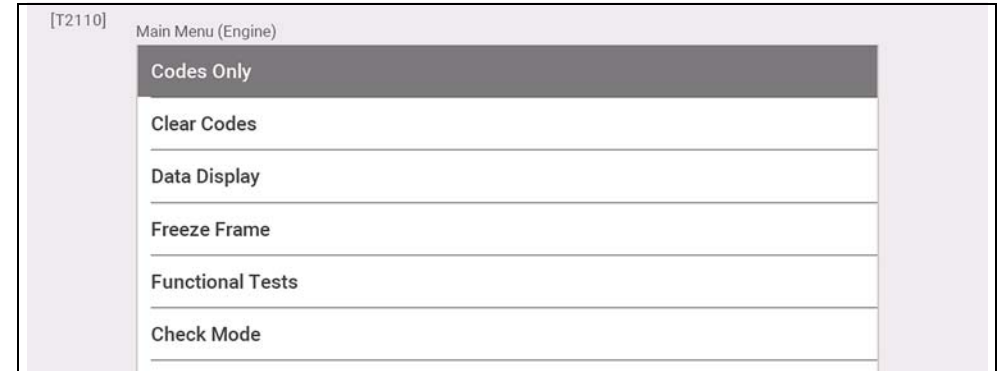

Figure 4-5



## 4.4 Working with Trouble Codes

The following sections describe a few trouble code functions found within a typical System Main Menu.

### **i** NOTE

*Trouble code functionality, availability, navigation and terminology is vehicle manufacturer dependent, and will vary.*

### 4.4.1 Code Scan

#### Navigation

**Home Screen:** [Typical] Scanner (Vehicle Identification) > (Vehicle System Menu) > (Code Scan)

**Code Scan** quickly scans all supported vehicle control modules for codes and OBD-II monitor readiness. See [Vehicle Code Scan on page 40](#) for information.

### 4.4.2 Codes Menu

#### Navigation

**Home Screen:** [Typical] Scanner (Vehicle Identification) > (Vehicle System Menu) > (Vehicle System Main Menu) > (Codes Menu)

To view trouble codes, select **Codes Menu** and then make any sub-menu selections as applicable (if available). Depending on the vehicle manufacturer, the “Codes Menu” and sub-menu selection names will vary (e.g Codes, Codes Menu, Codes Only, Codes (No Data), Service Codes, Display Codes, etc.).

### 4.4.3 Display Codes

#### Navigation

**Home Screen:** [Typical] Scanner (Vehicle Identification) > (Vehicle System Menu) > (Vehicle System Main Menu) > (Codes Menu) > (Display Codes)

Display Codes may be a sub-menu of the Codes Menu, and typically displays a list of the current trouble codes, however sub-menu selections may also be required ([Figure 4-6](#)).

### Intelligent Diagnostics

Intelligent Diagnostics may be available for a selected code from the Display Codes screen ([Figure 4-6](#)).



If active, select the **Diagnose** icon to open Intelligent Diagnostics, see [Intelligent Diagnostics on page 45](#) for additional information.

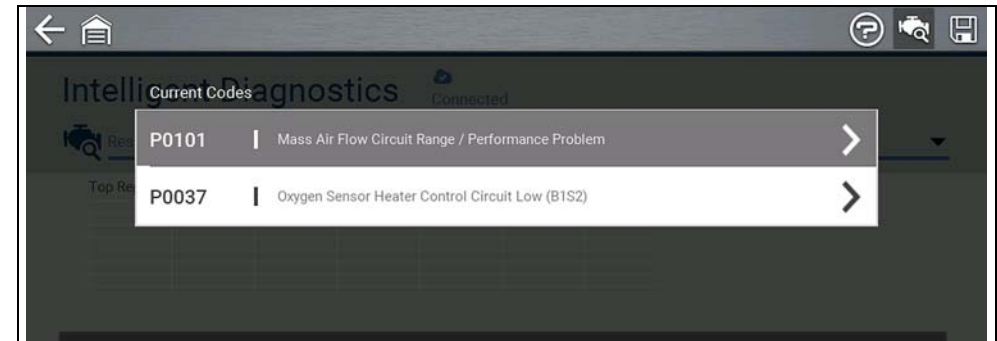

Figure 4-6



## 4.4.4 Freeze Frame/Failure Records

### Navigation

**Home Screen:** [Typical] **Scanner** (Vehicle Identification) > (Vehicle System Menu) > (Vehicle System Main Menu) > (Codes Menu) > (Display Codes) > (Freeze Frame/Failure Records)

**Freeze Frame/Failure Records.** may be a sub-menu of the Codes Menu and displays the last code that was set.



Selecting the **Freeze Frame** icon (*Figure 4-7*) displays the corresponding Freeze Frame data that was captured when the code was set.

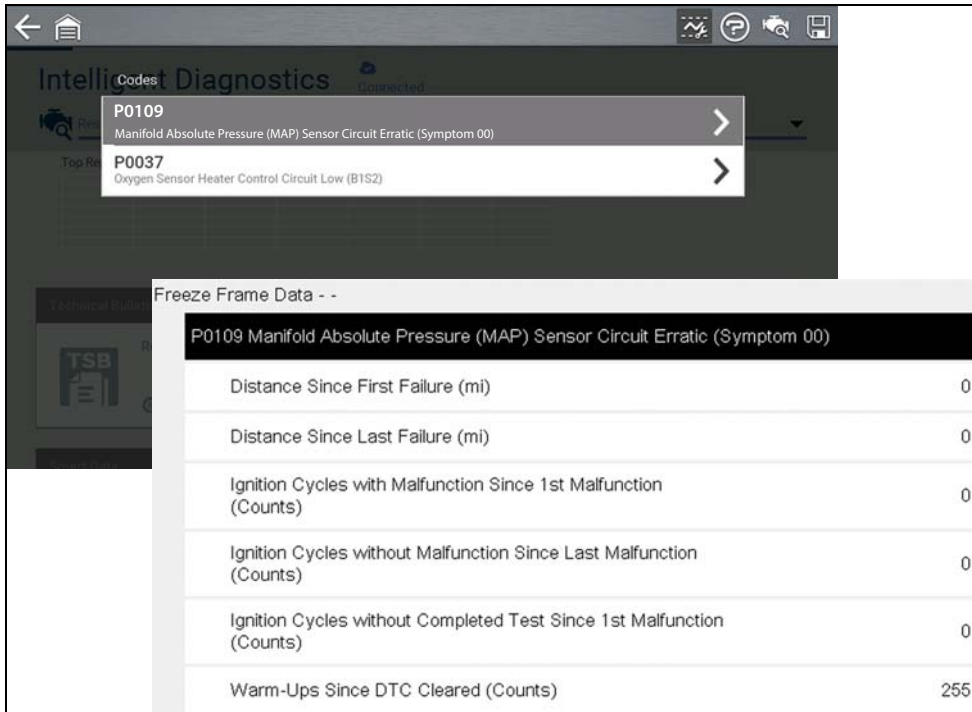

Figure 4-7

## 4.4.5 Clear Codes

### Navigation

**Home Screen:** **Scanner** (Vehicle Identification) > (Vehicle System Menu) > (Vehicle System Main Menu) > (Clear Codes)

**Clear Codes** allows you to erase codes from ECM memory.

### IMPORTANT

***Clearing codes erases all temporary ECM information, including Freeze Frame/Failure Records. Check and/or record all vital diagnostic information before clearing codes.***



## 4.5 Service Resets and Relearns

### Navigation

**Home Screen:** [Typical] Scanner (Vehicle Identification) > (Vehicle System Menu) > (Service Resets and Relearns)

The Service Resets and Relearns option, saves you time by providing you with a full menu of vehicle specific resets/relearns (functional tests) and related OEM information to help you successfully start and complete these services.

The number in the blue icon (*Figure 4-8*) indicates the number of resets and relearns supported for the vehicle.

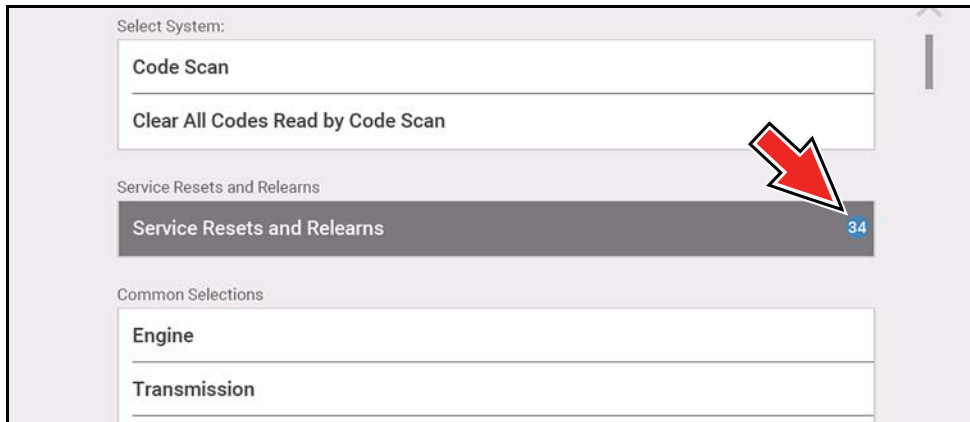

Figure 4-8

Selecting Service Resets and Relearns (from the System menu) (*Figure 4-8*), opens a categorized list of all the available resets and relearns (*Figure 4-9*).



Figure 4-9

Making a selection from the menu (*Figure 4-9*) opens the related information screen for that specific Reset/Relearn (*Figure 4-10*). The information provided may include:

- Top Repairs Graph - Shows the top repairs related to the selected Reset/Relearn
- TSB's and Safety Recall Links - (if available) provides links to related OEM service bulletins and safety recall information
- Functional Resets and Calibrations - Resets/Relearns that can be completed using the diagnostic tool

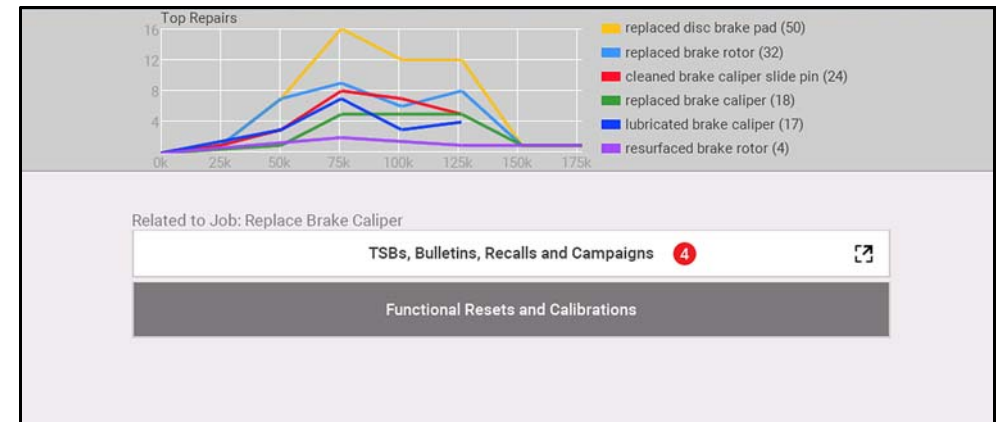

Figure 4-10

## 4.6 Working with Data (PIDs)

The following sections describe common data functions.

### NOTE

*Data functionality, availability, navigation and terminology is vehicle manufacturer dependent, and will vary.*

### 4.6.1 Data Menu

#### Navigation

**Home Screen:** **Scanner** (Vehicle Identification) > (Vehicle System Menu) > (Vehicle System Main Menu) > (Data)

To view Data, select **Data** and then make a sub-menu selection as applicable (if available). Depending on the vehicle manufacturer, the “Data” and sub-menu selection names will vary (e.g. Data, Data Menu, Data Only, Data Groups, Display Data, etc.).

The Data menu ([Figure 4-11](#)), displays available PID lists.

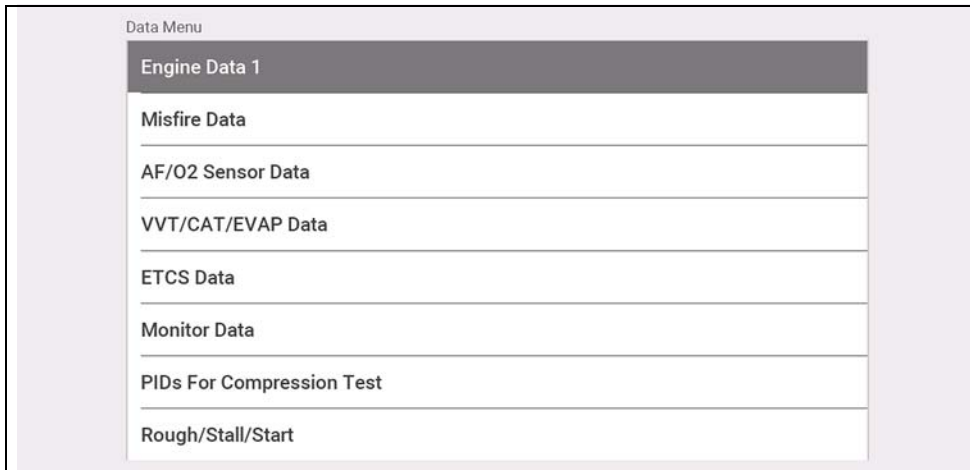

Figure 4-11

There are 3 basic PID list types:

- **All System Data** - display all available PIDs for that system. As an example from within an Engine system Data menu, the Engine Data option can be used to display all Engine related PIDs.
- **Related System Data** - display a list of PIDs that are related to the primary system (e.g. Misfire, EVAP, and Fuel Trim PID lists are related to the Engine system).
- **Custom Data** - user defined list of PIDs see [Custom Data Lists](#) on page 28.

### 4.6.2 Custom Data Lists

#### Navigation

**Home Screen:** **Scanner** (Vehicle Identification) > (Vehicle System Menu) > (Vehicle System Main Menu) > (Data) > (Specific Data List - e.g. Engine)



Select the **Custom Data List** icon to create a custom PID list ([Figure 4-12](#)) (add or remove PIDs from the list). Minimizing the number of PIDs displayed allows you to focus on specific data parameters and provides a faster refresh rate.



Figure 4-12

Check the parameters to display ([Figure 4-13](#)) and then select the **Accept** icon. The custom list displays ([Figure 4-14](#)).

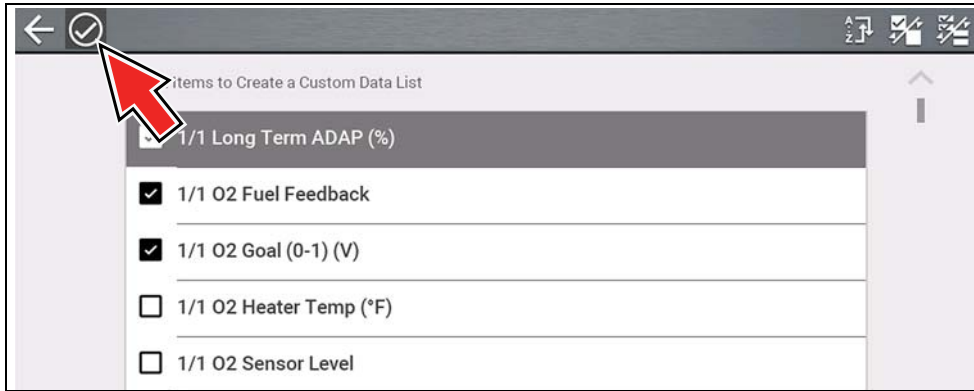

Figure 4-13

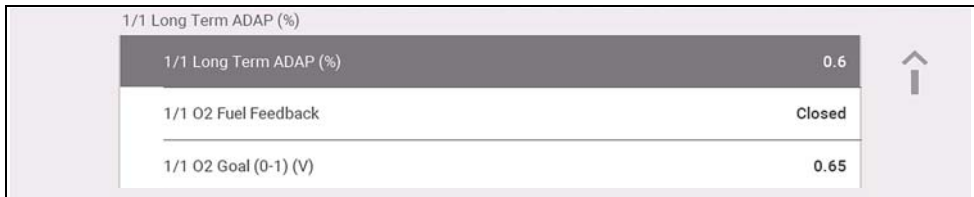

Figure 4-14

### 4.6.3 PID (Alarm) Indicator

Visual (alarm) indicators can be set for two state PIDs. Two state PIDs include components and circuits that only operate in two modes or “states” (e.g. solenoids, relays, and switches that are either, open/closed, on/off, true/false, etc.).



To set two state PID Indicators, select the **PID Alarm** icon.

Choose the PIDs indicators to display (*Figure 4-15*), then select the **Back** arrow. PID indicators are displayed in the data list (*Figure 4-16*), and change color as the states change.

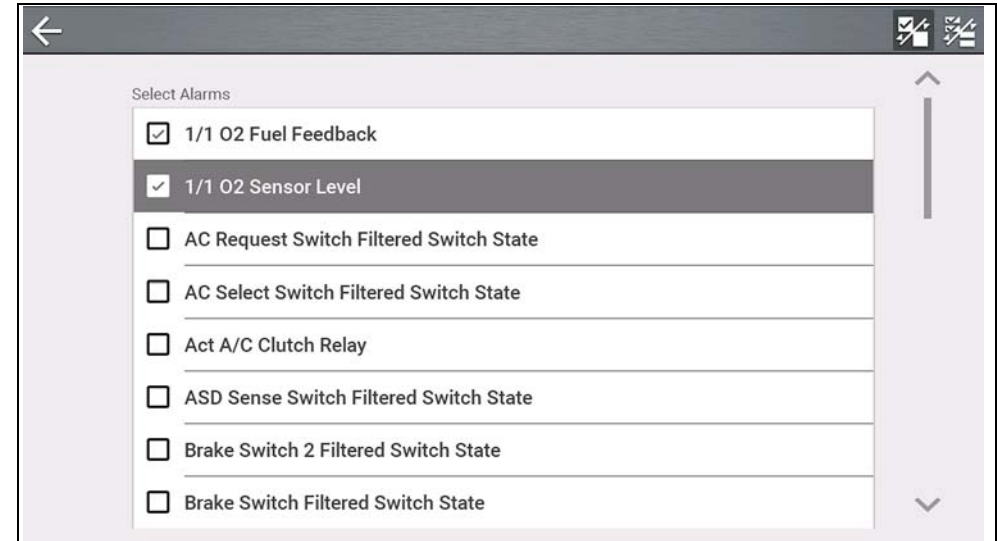

Figure 4-15

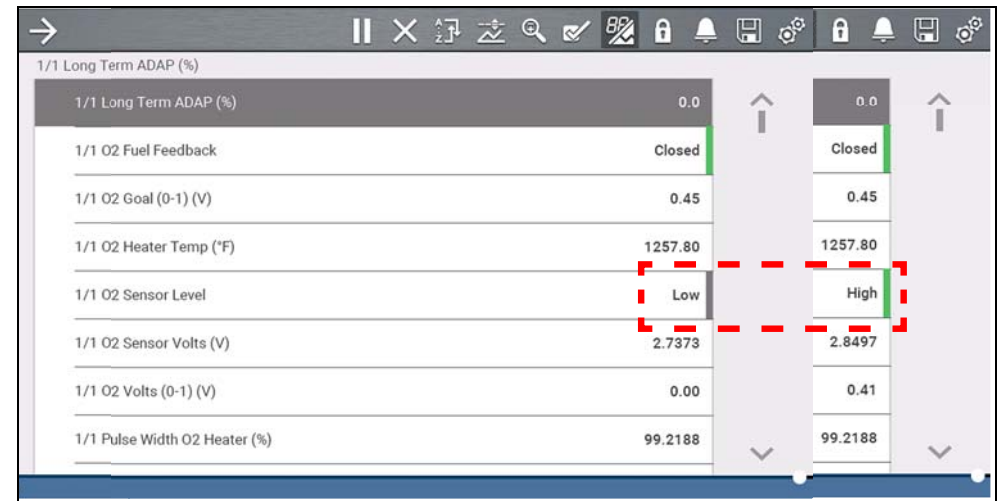

Figure 4-16

## 4.6.4 Data Views (List / Graph)

Data may be displayed in either list or graph form.

Figure 4-17 shows a four PID graph view (top) and PID list view (bottom).



To change the data display type, select the **View** icon.

In all views, the current parameter value or state is shown, and the PIDs are listed in the order in which they are transmitted by the ECM.



Select the **Right Arrow** to display the next data list when more than one list is available.

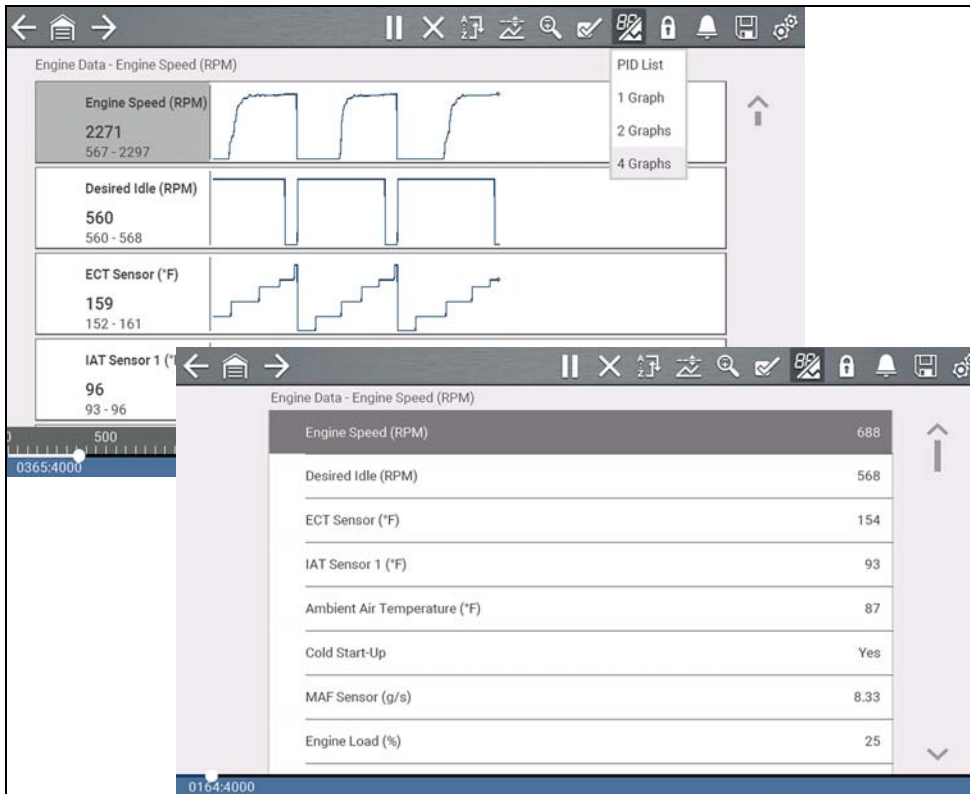

Figure 4-17

In graph view the text block (Figure 4-18) to the left of the graph displays:

- Top - PID description
- Middle - Current value or state

- Bottom - Active minimum and maximum values

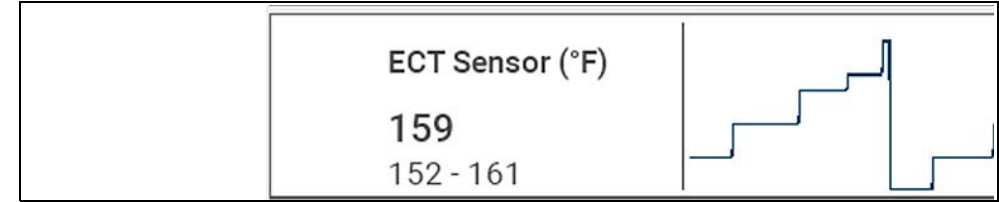

Figure 4-18

## 4.6.5 Locking PIDs (to always display at top)



Use the **Lock** icon to lock selected PIDs at the top of the list.

To lock or unlock a PID, highlight the parameter and select the **Lock** icon.

### NOTE

Only three parameters can be locked at one time. Once locked, a parameter remains locked until it is manually unlocked, or communication with the vehicle is stopped.

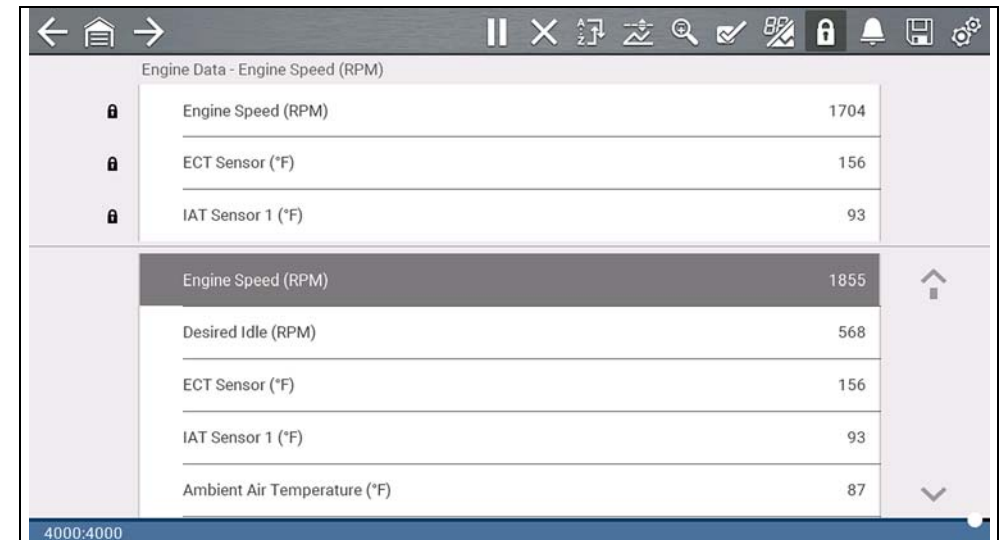

Figure 4-19

## 4.6.6 About the Data Buffer

The diagnostic tool has the capability to collect, store and save PID data utilizing internal storage memory and buffer memory.

When data is displayed onscreen, a data buffer automatically starts to store it in buffer memory. The data buffer runs continuously (storing data) until the Pause, Clear, or Save icon is selected.

Buffer memory is limited to a predetermined "total" size. When buffer memory reaches it's full capacity, the data buffer will continue to store new data, however earlier stored data will be removed to allow room for the new data being stored.

The most recent data is always available for review when Pause is pressed, and can be reviewed using the toolbar controls.

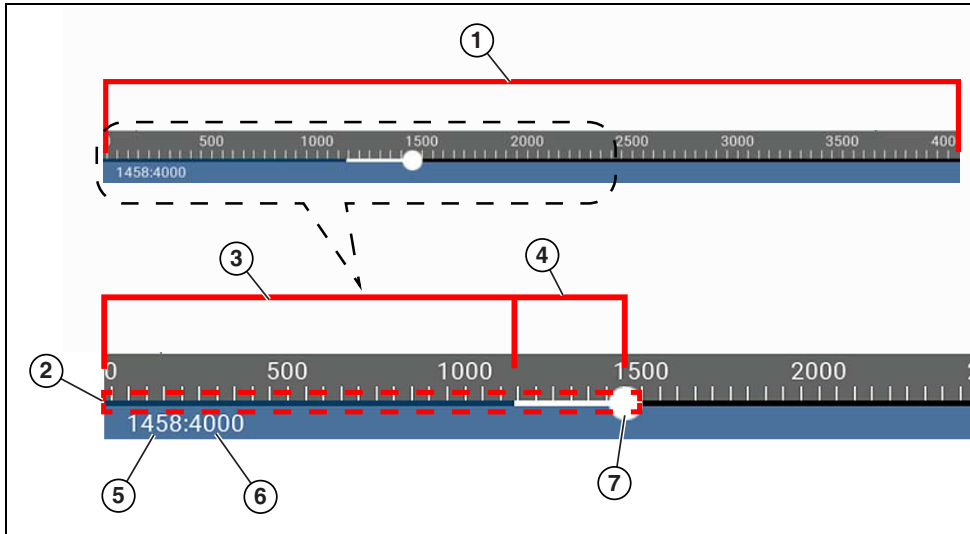

Figure 4-20

- 1— **Data Buffer Scale** - Displays maximum data buffer size (e.g. 4000) across screen
- 2— **Data Buffer Indicator** - Bar graph indicates total data stored in the memory buffer. Includes blue and white graph bars and active position indicator.
- 3— **Blue Graph Bar** - Stored data not displayed onscreen
- 4— **White Graph Bar** - Stored data displayed onscreen
- 5— **Active Data Position Counter** - the numerical position of the active (current) data point as displayed within buffer memory.

- 6— **Maximum Data Buffer Size** (Data Buffer Position Counter) - indicates the maximum data buffer size value (e.g. 4000)
- 7— **Active Data Position Indicator** - Round icon indicates active (current) position in the data, which is also denoted by the Active Data Position Counter.

Figure 4-21 shows the relationship between the (Blue) Current Position Cursor, Active Data Position Indicator and Active Data Position Indicator during data review.

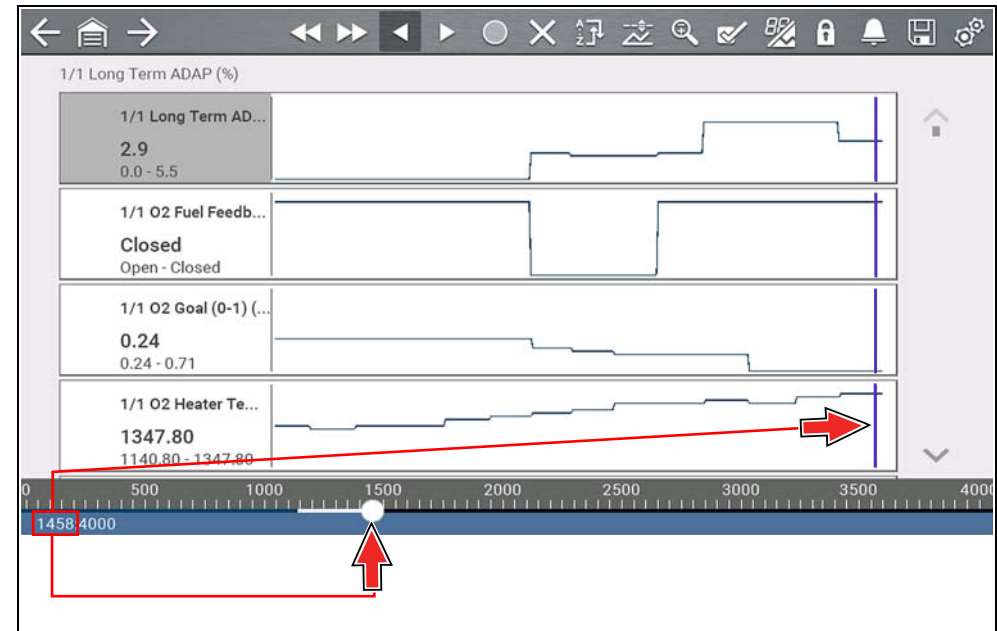

Figure 4-21



## 4.6.7 About Cursors

Vertical cursors are automatically displayed (in graphical PID views) to mark specific data reference points.

**Gray (Pause/Save)** - If you select Pause or Save while collecting data, a vertical gray cursor is automatically placed at that point in the data to indicate where the data was paused or saved.

- Each time Pause is pressed an additional cursor is added, and appears when Start is pressed to resume data collection.
- Each time Save is pressed an additional cursor is added, and appears when the data starts again after a slight pause to save the file.
- Cursors are displayed in all PIDs as reference markers.
- Cursors are retained and appear in saved data files.

**Blue (Current Position)** - If you select Pause while collecting data, a vertical blue cursor is displayed as an indicator to your position in the data and is denoted by the current position value in the counter display.

- Cursors are displayed in all PIDs as reference markers.
- Depending on the amount of data saved the blue cursor may be initially located on the far left next to the description, or the far right next to the scroll bar making it difficult to see. If this happens, use the control icons (Step/Skip) to move the data until you can see the cursor.

**Red (Triggered PID Activation Point)** - When using triggers, a vertical red cursor is displayed in the data of the triggered PID at the point where the trigger was activated.

- When multiple PIDs are armed, only the PID that is triggered first will display a red cursor.

**Green (Trigger Activation Reference Point)** - When using triggers, green vertical cursors are displayed in all PIDs (except the PID that was triggered) as reference to the triggered PID activation point.

- When a trigger is activated the displayed red and green cursors are all vertically aligned in the graphed data to show the relationship of the trigger point in all PIDs.

## 4.6.8 Pausing and Reviewing Active Data

During normal operation, data from the vehicle is continuously being stored in buffer memory as it is displayed onscreen. The Pause icon ([Figure 4-22](#)), allows you to temporarily pause data collection to review it in detail.

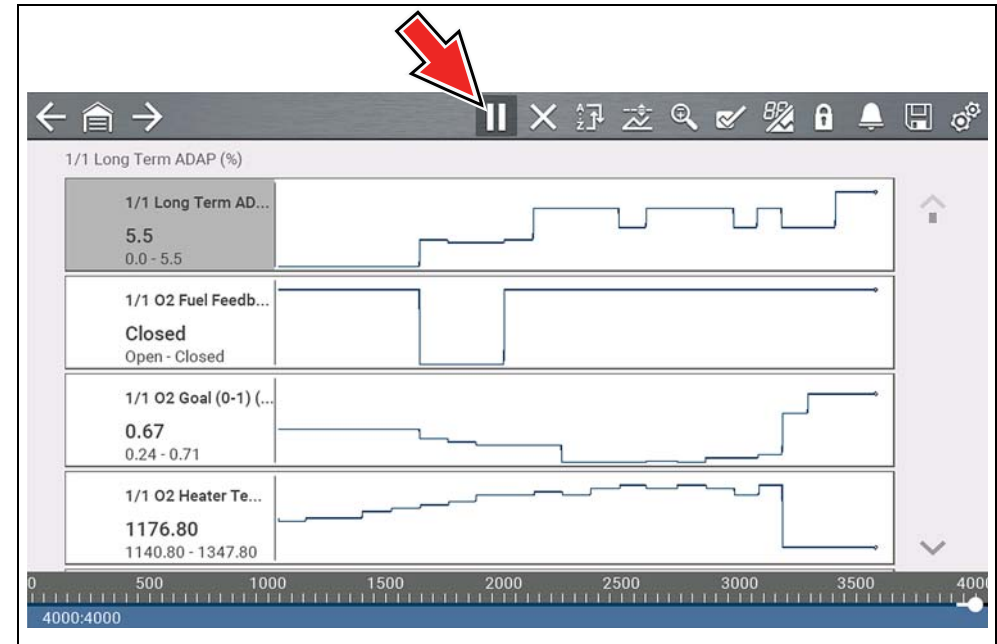

Figure 4-22

After Pause is pressed:

- Use the review control icons ([Figure 4-23](#)) to accurately move through the data.
- The blue (vertical cursor) ([Figure 4-23](#)) indicates your position in the data and is denoted by the current position value in the counter display. This cursor displays in all PIDs.

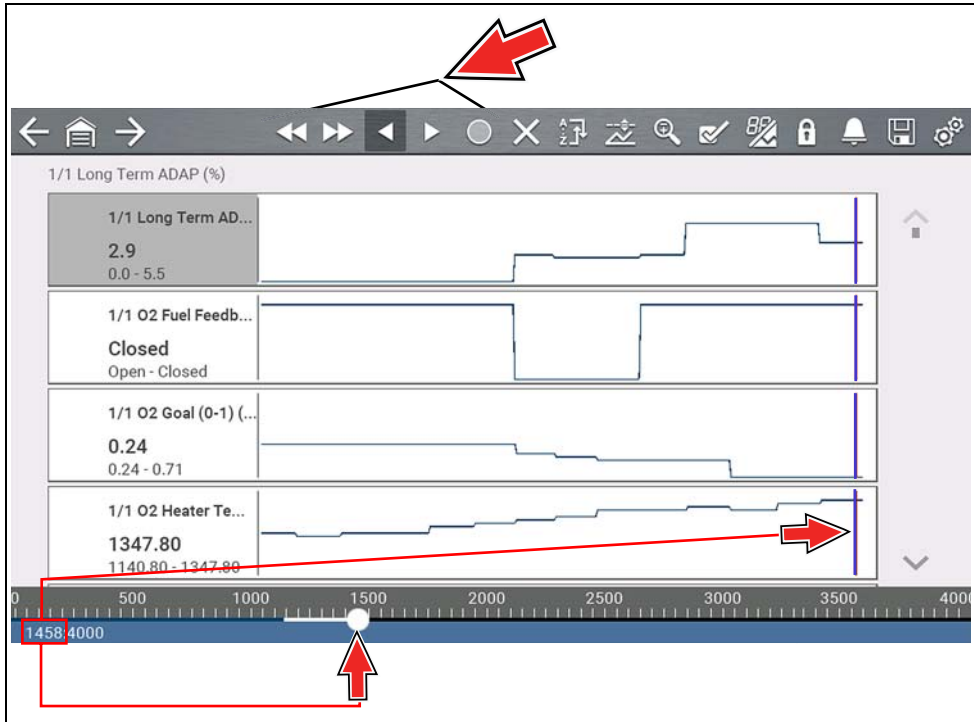



Figure 4-23

To resume data collection (after pausing), select the **Start** icon .

- The screen changes back to display data ([Figure 4-24](#)).
- A vertical gray cursor is displayed on all PIDs, indicating where the data was paused ([Figure 4-24](#)). If Pause occurred more than once, gray cursors will be used for each instance.

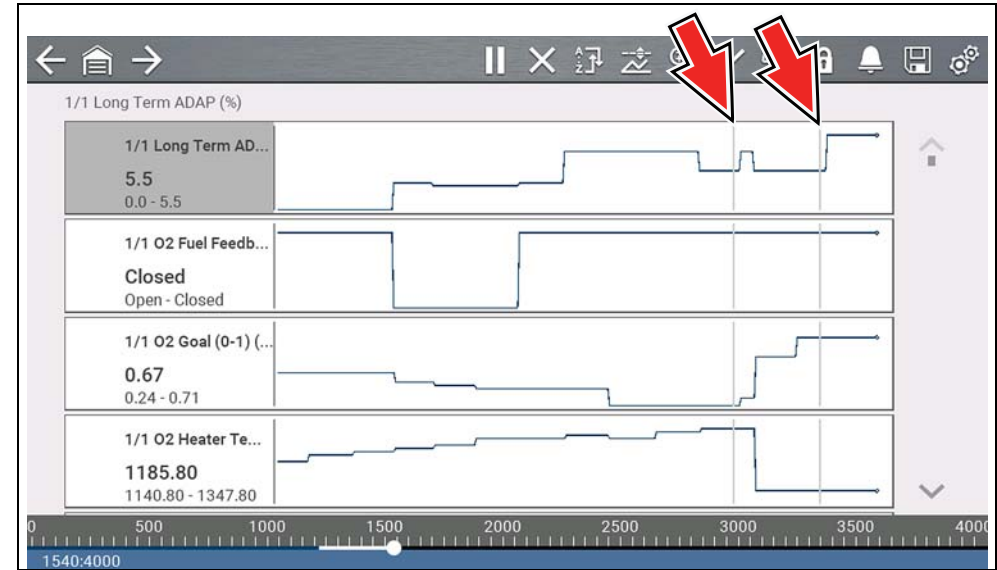

Figure 4-24

#### 4.6.9 Saving Data Files



Saving data is useful when trying to isolate an intermittent problem or to verify a repair. During normal operation, data from the vehicle is continuously being stored in buffer memory as it is displayed onscreen.

Selecting the **Save** icon writes stored buffer memory to a (.SCM) file.

#### **i** NOTE

The **Save icon** performs the same function as “Save Movie” function choice for the programmable **Shortcut** button, see [Configure Shortcut Key](#) on page 73 for details.

## 4.6.10 Viewing Data Files

### Viewing Data Files on the Tool

#### Navigation

**Home Screen:** [Previous Vehicles and Data > Saved Data](#)

1. Select the desired data file (.SCM file extension), see [Saved Data on page 71](#) for additional information.
2. Change the view type and zoom levels as needed.
3. In graph view, use the control icons to move through the data ([Figure 4-25](#)).

The blue (vertical cursor) ([Figure 4-25](#)) indicates your position in the data and is denoted by the current position value ([Figure 4-25](#)) in the counter display. The cursor displays in all PIDs.

Depending on the amount of data saved the cursor may be initially located on the far left next to the description, or the far right next to the scroll bar making it difficult to see. If this happens, use the control icons to move the data until you can see the cursor.

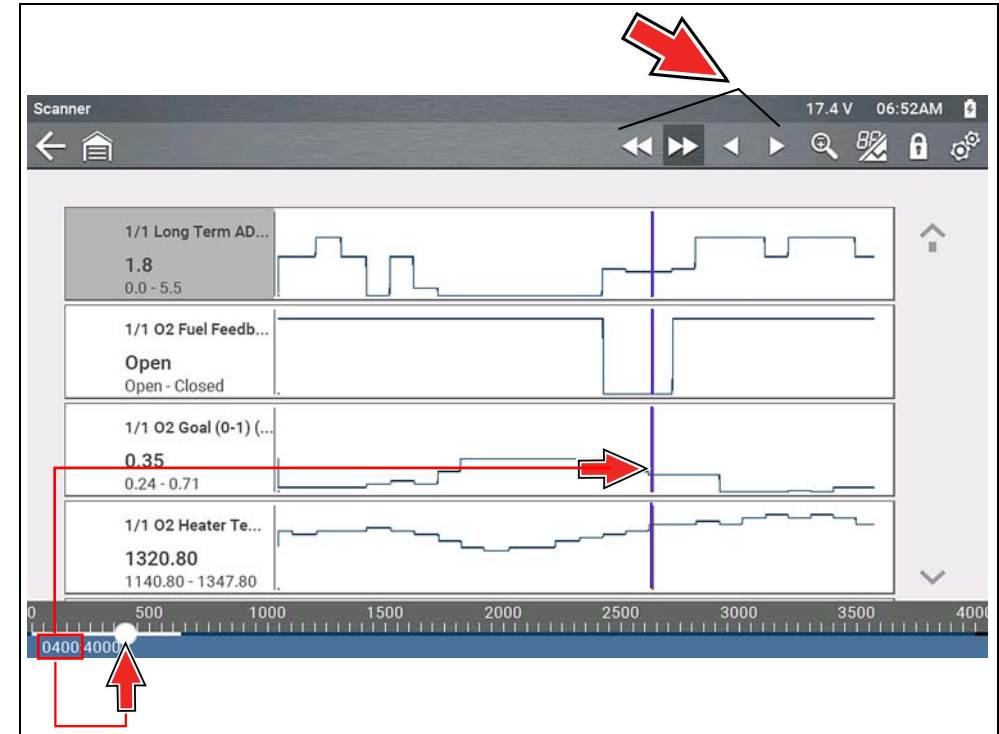

Figure 4-25

### Viewing Data Files on a PC

Saved data files can also be downloaded to a personal computer (PC) using the supplied USB cable and *ShopStream Connect™*. See [Connect-to-PC \(File Transfer\)](#) on page 73.

## 4.6.11 Using Zoom



The zoom function allows you to change the magnification level of the graphed data during data collection and review. Changing magnification levels allows you to compress or expand the displayed data to quickly find glitches, or signal losses.

When the **Zoom** icon is selected the dropdown menu allows you to select the display magnification level from a range of -2X to +8X. The "Zoom Out" option displays up to half of the maximum amount of data that can be collected, on one screen. The default magnification level is 1x.



Examples *Figure 4-26*: Top (+4X), Middle (1X), Bottom (Zoom Out)

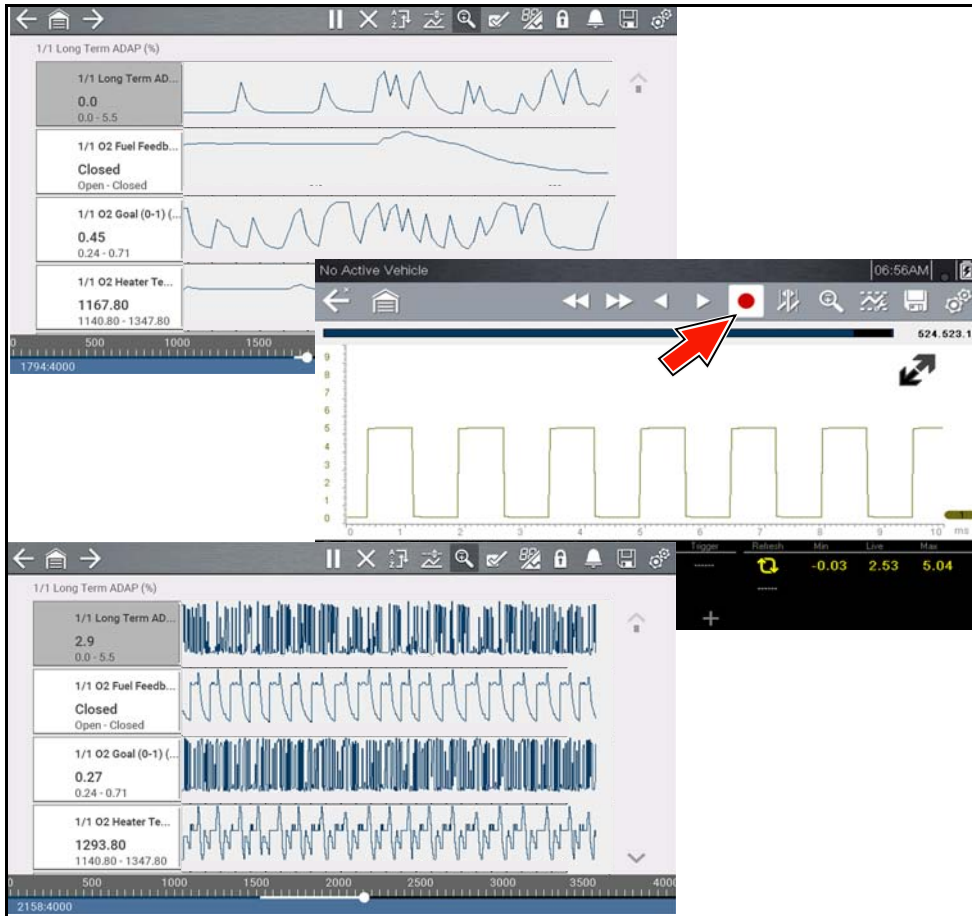

Figure 4-26

## 4.6.12 Using Triggers

### Trigger Description and Features



Setting PID triggers allows you to configure the diagnostic tool to automatically save PID data to a file when a PID value meets an upper/lower limit (trigger point).

When a PID value meets the trigger point it activates the trigger which captures a short recording of PID data (before and after the trigger event), and saves it as a data file.

You can then review the file to evaluate the PID that triggered the event, and all the PIDs collectively to determine what happened up to and just past when the event occurred.

Examples of the following trigger states (Armed / Not Activated - upper image) and (Activated - lower image) are shown in (*Figure 4-27*).

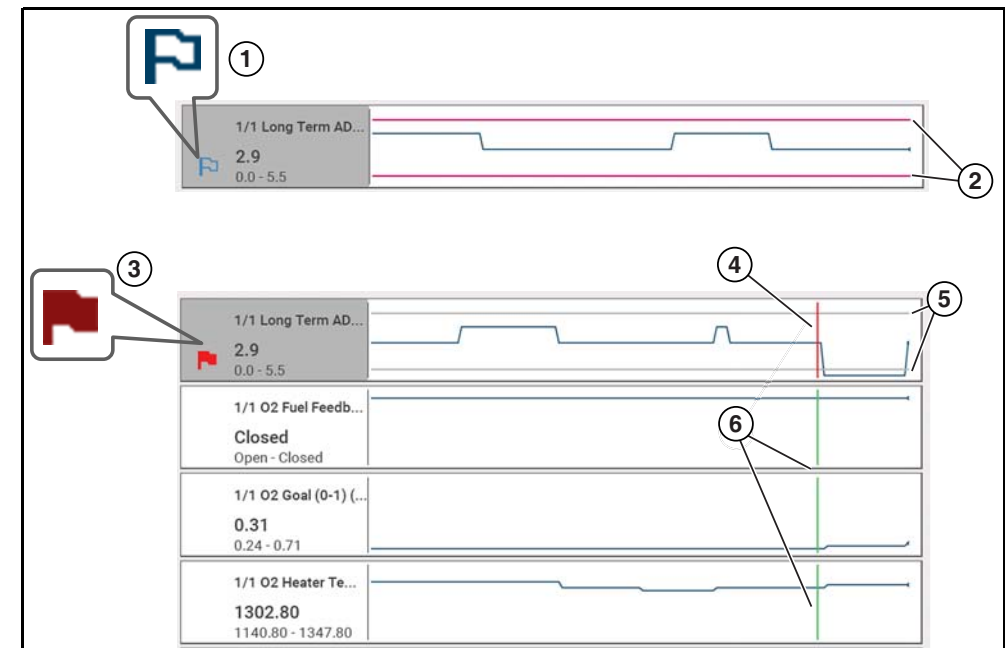



Figure 4-27

**1— Armed PID Trigger Indicator** - A blue outlined flag indicates the PID trigger is armed.

- 2— **Upper and Lower Limit Lines (Armed)** - Colored limit lines indicate the trigger is armed but not activated.
- 3— **Activated PID Trigger Indicator** - A red flag indicates the PID trigger has activated.
- 4— **Trigger Activation Point Cursor** - A red cursor line is displayed in the PID data where the trigger was activated.
- 5— **Upper and Lower Limit Lines (Not Armed and Activated)** - Gray limit lines are displayed when the trigger is armed but not activated and after the trigger has been activated.
- 6— **Trigger Activation Point Reference Cursor** - Green cursors lines are displayed on all the other PID graphs to indicate their relationship to where the trigger occurred.

### PID Trigger Status Icons

The icons (below) are used to help you quickly identify the status of individual PID triggers:

Icon	Description
Trigger Armed	
	Trigger has been set (configured) and is armed.
Trigger Activated	
	Trigger has been activated (upper or lower limit has been met).

### ▶ Setting triggers:

To use triggers, they must be turned on (set/configured), and then armed. Use the following procedures to setup PID triggers.

1. Highlight the PID to setup with a trigger.
2. Select the **Trigger** icon.

Selecting the **Trigger** icon ([Figure 4-28](#)) displays trigger menu options:

- **Set Trigger**—opens setup screen for upper/lower limits (trigger points)
- **Arm Trigger**—arms the trigger to capture data
- **Clear All Triggers**—deletes all previously set triggers

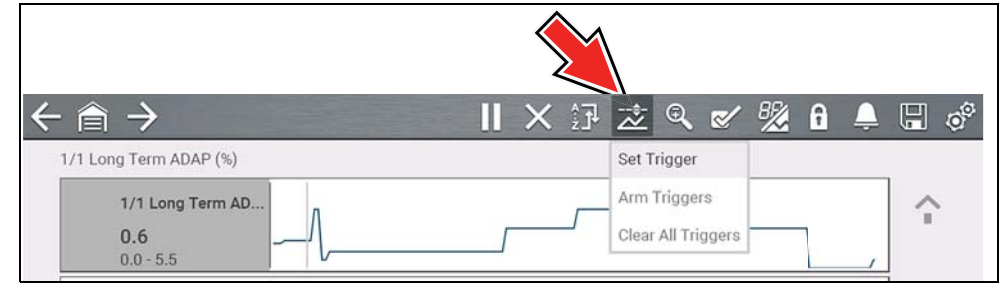

Figure 4-28

If triggers are already set, the menu options are:

- **Clear Trigger**—deletes the highlighted trigger
- **Disarm Trigger**—disarms the highlighted trigger
- **Clear All Triggers**—deletes all set triggers

3. Select **Set Trigger**.

A graph of the highlighted PID and setup icons display ([Figure 4-29](#)).

The upper trigger point must be set first. A red horizontal line is displayed across the data graph ([Figure 4-29](#)) representing the upper trigger point.

4. Use the lower toolbar arrow icons ([Figure 4-29](#)), or the up ▲ and down ▼ arrow buttons to change the position of the upper trigger point.
5. Select ✓, or press the Y/✓ button, to set the upper trigger point.

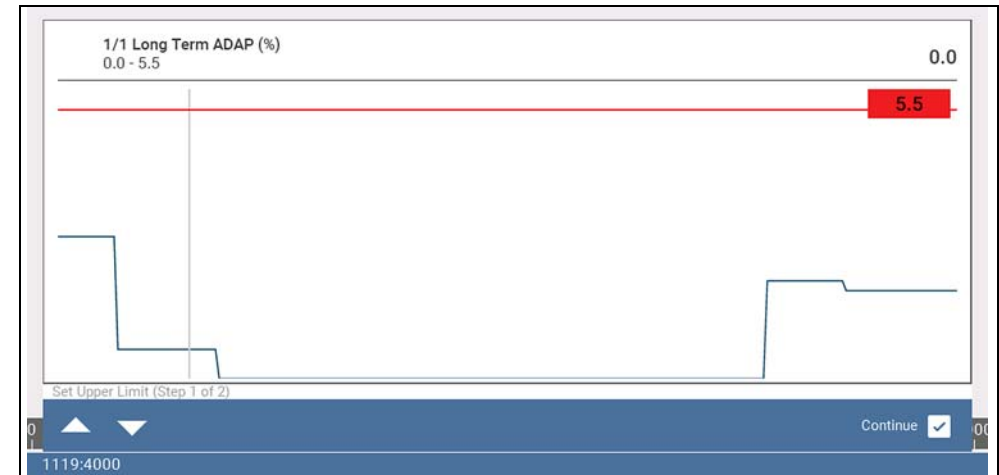

Figure 4-29

The upper trigger line changes color to gray and the lower trigger line displays in red (*Figure 4-30*).

- Change the position of the lower trigger line in the same manner as the upper.
- When finished, select ✓, or press the **Y/✓** button, to set the lower trigger level.

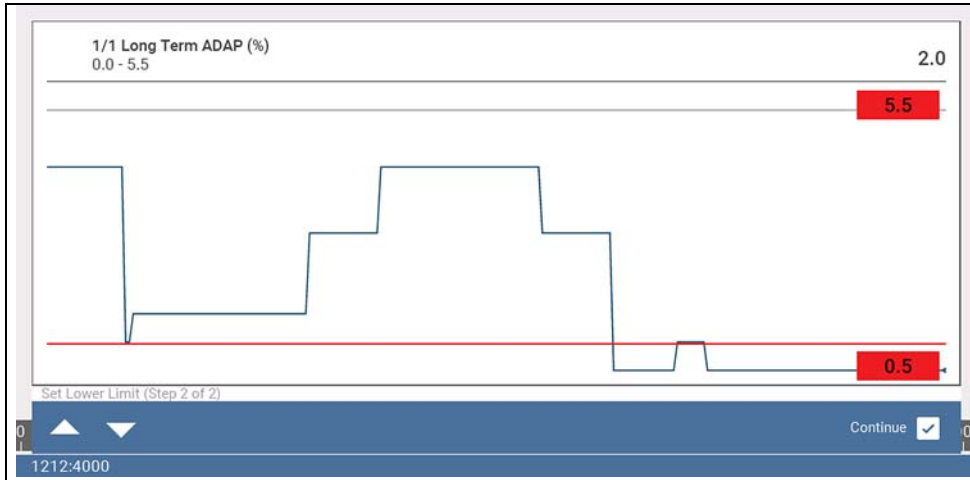

Figure 4-30

The display returns to the PID data view and the trigger points appear as horizontal lines across the designated graph (*Figure 4-31*). Repeat this procedure to establish trigger points for other parameters (up to three) if desired.

## NOTE

*Only three parameters can have trigger levels set at one time, but only one of the conditions needs to be satisfied for triggering to occur.*



Figure 4-31

## ▶ Arming triggers:

- Select the **Trigger** icon.
- Select **Arm Triggers**.

The trigger point lines change color to indicate an armed condition (*Figure 4-32*).

All set PID triggers are armed simultaneously (if more than one is set). Once armed it remains armed until you clear it or the trigger is activated.

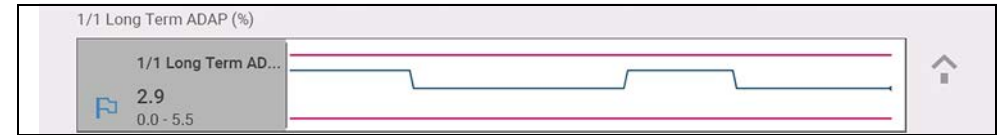

Figure 4-32

## About Activated Triggers

A trigger is activated (displays red flag)  when a PID value meets an upper/lower limit (trigger point).

When a trigger is activated:

- Data collection is briefly paused as the Scanner captures a short recording of PID data (before and after the trigger event), and saves it as a data file.
- A gray cursor line is displayed to indicate the point at which the data was paused or saved.
- An audible alarm is sounded
- A message displays indicating a data file was saved.
- Data collection continues.
- The activated PID trigger is disarmed. **Note** - if a different PID trigger is activated subsequently, an additional data file will be recorded.
- A red cursor line is displayed on the graph of the PID with the activated trigger to indicate where the trigger occurred. A green cursor line is displayed on all the other PID graphs to indicate their relationship to where the trigger occurred.
- The trigger menu options are:
  - Clear Trigger**—deletes the highlighted trigger
  - Arm Trigger**—arms the trigger to capture data
  - Clear All Triggers**—deletes all set triggers

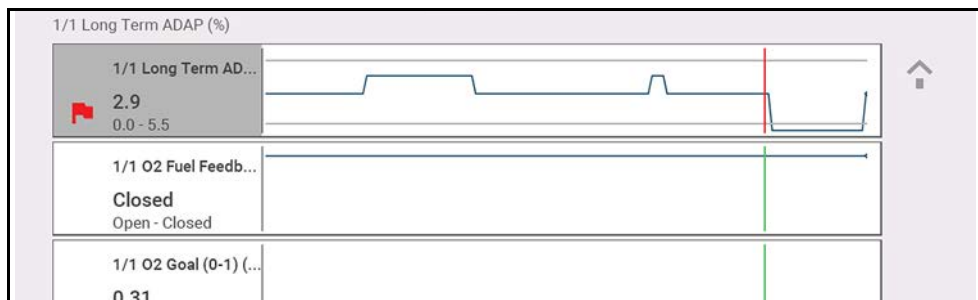

Figure 4-33

## 4.7 Functional Tests

### Navigation

**Home Screen:** **Scanner** (Vehicle Identification) > (Vehicle System Menu) > (Vehicle System Main Menu) > (Functional Tests)

**Functional Tests** provides access to vehicle-specific subsystem tests.

### NOTE

*Functional Test functionality, availability, navigation and terminology is vehicle manufacturer dependent, and will vary.*

Typical functional tests:

- **Information Tests**—read-only tests (i.e. selecting “VIN” to display the VIN of the vehicle).
- **Toggle Tests**—component state change tests (i.e. switching a solenoid, relay, or switch, between two operating states).
- **Variable Control Tests**—command variable value tests (i.e. varying spark timing in 1° increments or EGR valve duty cycle in 10% increments).
- **Reset Tests**—reset the adaptive, or learned, values that are stored in the vehicle electronic control module memory.
- **Scripted Tests**—preconfigured tests that are run when performing certain repairs (i.e. bleeding brakes with ABS).

## IMPORTANT

*Follow all screen instructions while performing tests.*

Different toolbar controls are used depending on the functional test. Some tests use a Test icon to switch actuators on/off, and some require variable controls selection to increase and decrease a testing value.

Some tests provide a Data List icon, which allows you to change which data displays.

Toggle and variable control tests often display functional test controls on the toolbar at the top of the screen with PID data in the main body.



## 4.8 Troubleshooter

### Navigation

**Home Screen:** **Scanner** (Vehicle Identification) > (Vehicle System Menu) > (Vehicle System Main Menu) > (Troubleshooter)

## IMPORTANT

*Troubleshooter information is only applicable for select vehicles up to and including the 2015 model year. Troubleshooter is dependent on the availability of information, and is not available for all vehicles.*

Troubleshooter provides reference information from actual repairs. Code tips, parameter descriptions, along with repair guidelines are some of the information that may be included.

Typical information:

- **Code Tips**—provides detailed information on setting conditions, testing, and interpreting test results for specific codes.
- **Symptom Tips**—provides diagnostic tests and procedures based on vehicle operation.
- **Time Savers**—provides supplemental information, such as firing order and #1 cylinder location, that may be needed to make a diagnosis.



- **Common Problems**—provides advice and remedies for certain “pattern failures” that have been experienced on vehicles of the same model.
- **Tests and Procedures**—explains how to perform certain tests on the specific test vehicle. Some tips provide specifications and installation information as well.
- **Data Scan**—contains information and guidelines on how to validate data readings for certain sensors and actuators, PID data values are provided.
- **Fixes**—provides actual repair information for related repairs.

# Section 5

# Vehicle Code Scan



Code Scan allows you to quickly scan all supported vehicle control modules for codes and monitor readiness.

## Wi-Fi Required



Wi-Fi connection is required to use certain functions of this feature. See [Wi-Fi Connection / Troubleshooting](#) on page 77.

### IMPORTANT

**PRE / POST Scan Importance - As many systems do not turn on the check engine light or other indicator, performing a vehicle code scan before making any repairs may help in troubleshooting, by identifying possible unknown issues that may be related to the present symptoms.**

**Performing pre and post scans also allows you to record in report format the pre-condition of the vehicle and compare the post scan after work is complete to confirm the repairs were completed properly.**

**Pre and post scan is required by some manufacturers for collision work as well as by some insurance companies.**

Page: 1 2016 Nissan Rogue 2.5L L4 MFI (QR25DE) Date: 04/01/2020 10:16AM

### Pre-Scan Vehicle System Report

2016 Nissan Rogue 2.5L

VEHICLE INFORMATION

VIN: JN8ASMT0FW000000  
 MAKE: Nissan  
 YEAR: 2016  
 MODEL: Rogue  
 ENGINE: 2.5L L4 MFI (QR25DE)  
 SYSTEM: CodeScan  
 LICENSE PLATE:  
 ODOMETER:

NOTES

CODE SCAN RESULTS

Systems Analyzed: 10

- Engine: 0
- Transmission: 0
- Antilock Brakes: 0
- Airbag: 0
- Body Control Module - Codes: C1707 | Low Pressure Left Rear
- Electronic Power Steering: 0
- Intelligent Power Distribution Module: 0
- Meter: 0
- Tire Pressure Monitor - Codes: C1704 | Low Pressure Left Front, C1706 | Low Pressure Right Rear, C1707 | Low Pressure Left Rear
- OBDII: 0

VEHICLE INFORMATION

VIN: JN8ASMT0FW000000  
 MAKE: Nissan  
 YEAR: 2016  
 MODEL: Rogue  
 ENGINE: 2.5L L4 MFI (QR25DE)  
 SYSTEM: CodeScan  
 LICENSE PLATE:  
 ODOMETER:

NOTES

CODE SCAN RESULTS

Systems Analyzed: 10

- Engine: 0
- Transmission: 0
- Antilock Brakes: 0
- Airbag: 0
- Body Control Module: 0
- Electronic Power Steering: 0
- Intelligent Power Distribution Module: 0
- Meter: 0
- Tire Pressure Monitor: 0
- OBDII: 0

READINESS MONITORS

Tests Complete

- Misfire
- Fuel System
- Comprehensive Component
- EGR/VVT
- Catalyst
- Evaporative System
- Oxygen Sensor
- Oxygen Sensor Heater

READINESS MONITORS

Tests Complete

- Misfire
- Fuel System
- Comprehensive Component
- EGR/VVT
- Catalyst
- Evaporative System
- Oxygen Sensor
- Oxygen Sensor Heater

Figure 5-1

## 5.1 Using Code Scan

### NOTE

Code Scan is not supported on all vehicles.

### Navigation

Home Screen: **Scanner > (Identify Vehicle) > Code Scan (System Menu)**

Select **Code Scan** from the System menu (*Figure 5-2*).



Figure 5-2

Choose which type of **Code Scan**, **Pre** or **Post Scan** (*Figure 5-3*). This selection determines the type of report header that is displayed, see *Figure 5-1* for example.

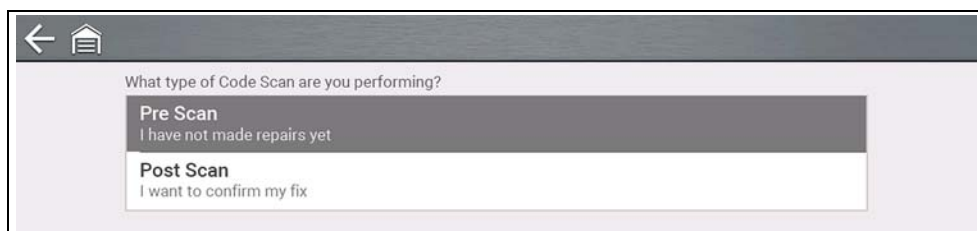

Figure 5-3

**Code Scan** runs an active scan of vehicle control modules, and then displays the results (*Figure 5-4*).

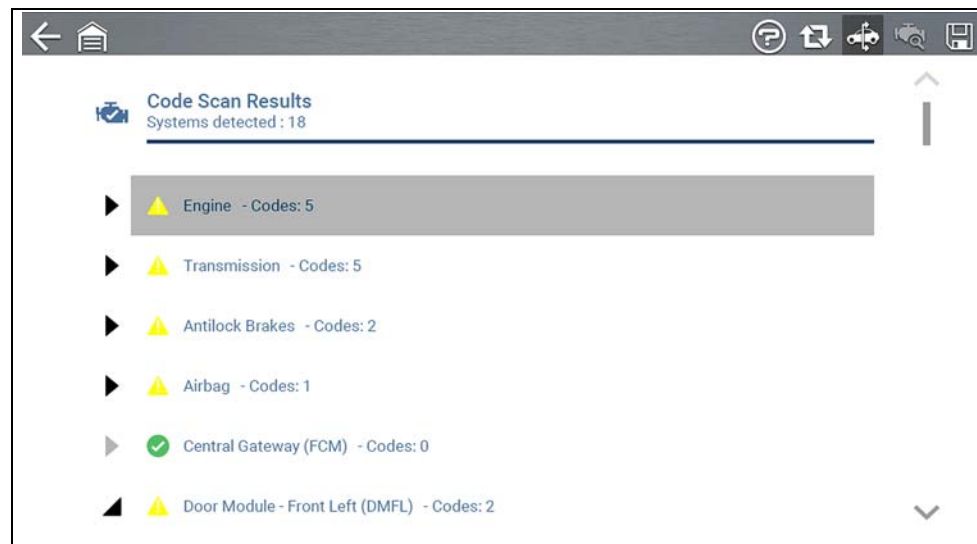

Figure 5-4

Code Scan result descriptions are provided in the following sections.





After the code scan has completed it is automatically saved as an .XML file on the diagnostic tool, and is uploaded to your Snap-on Cloud account.

- To view the report on the diagnostic tool, see [Viewing /Printing Saved Codes and Code Scan Results](#) on page 71.
- To view/print the report on the Snap-on Cloud, see [Vehicle System Report](#) on page 44.

### IMPORTANT

**Selecting Clear All Codes Read by Code Scan erases all DTCs from all vehicle system modules that were read by Code Scan. Selecting this function may not clear global OBD-II codes on some vehicles.**



Code Scan Icons	
	Refresh - Refreshes (restarts) the code scan
	System - Opens the main menu of the system selected (highlighted)
	Diagnose - Opens <a href="#">Intelligent Diagnostics</a> for the code selected (highlighted)
	Save - Saves the code scan results as an (.XML) file. See <a href="#">Viewing /Printing Saved Codes and Code Scan Results</a> on page 71.
	Help - Opens the Getting Started with Intelligent Diagnostics demonstration. See <a href="#">Demonstration</a> on page 45.

### 5.1.1 Total Number of Systems (modules) Analyzed

The total number of systems analyzed is actively displayed at the top of the screen as they are scanned.

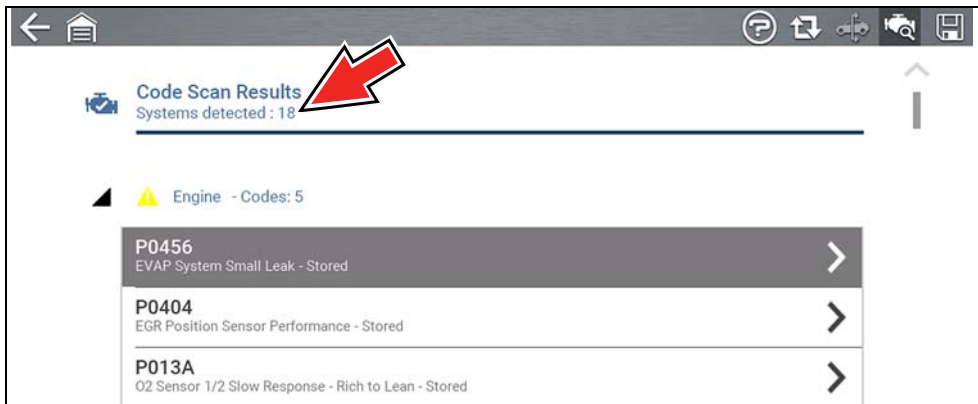

Figure 5-5

### 5.1.2 List of All the Systems Analyzed with DTCs Totals

A categorized system list with DTC totals is displayed in the order they are scanned. To view the main menu for a system in the list, select the system or select the **System** icon ([Figure 5-6](#)).

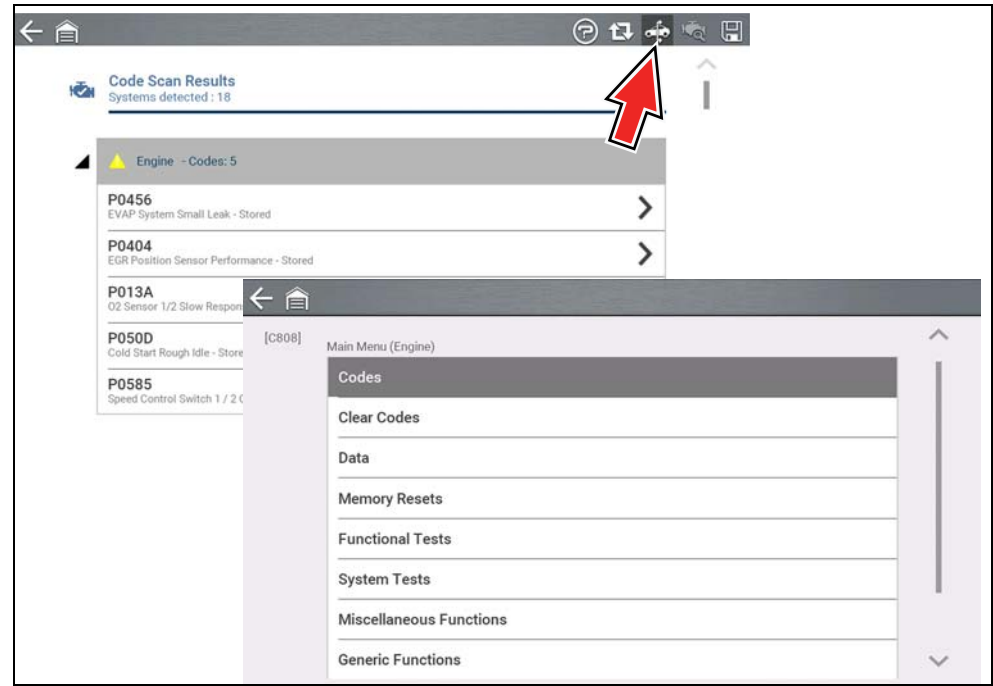

Figure 5-6



Select the **expand/collapse** icon (*Figure 5-7*) on the left side of a system category title to expand or collapse a systems' DTC list.

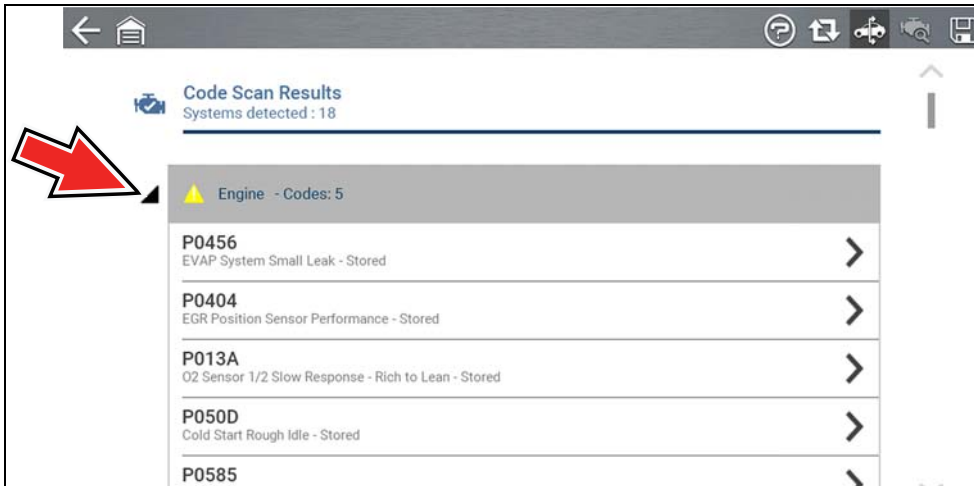

Figure 5-7

### 5.1.3 Global OBDII DTCs

Towards the end of the Code Scan list Global OBDII DTCs are displayed.

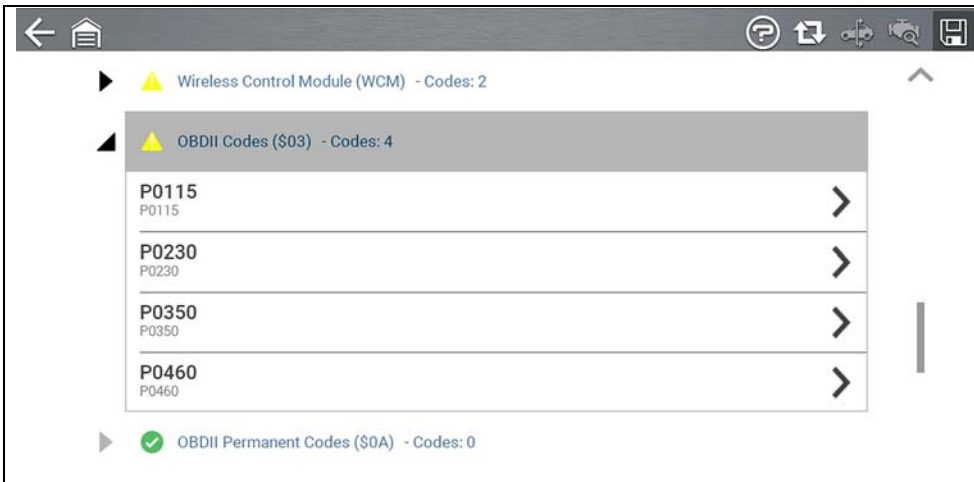

Figure 5-8

### NOTE

Some 2005 to 2008 vehicles may not display global OBD-II information in the Code Scan list. A message will be displayed to inform you the OBD-II - codes and monitors for this vehicle may be accessed using the global OBD-II function. See [OBD-II/EODB](#) on page 63.

### 5.1.4 Readiness Monitor Test Status

At the end of the Code Scan list, readiness monitor test results are displayed as "Tests Complete" or "Not Complete".

Quick reference indicators are used to show monitor status.

- Green icon "✓" mark - Monitor test is complete
- Grey icon "—" mark - Monitor test is not complete

Monitors that are not supported by the vehicle are not displayed in Code Scan.

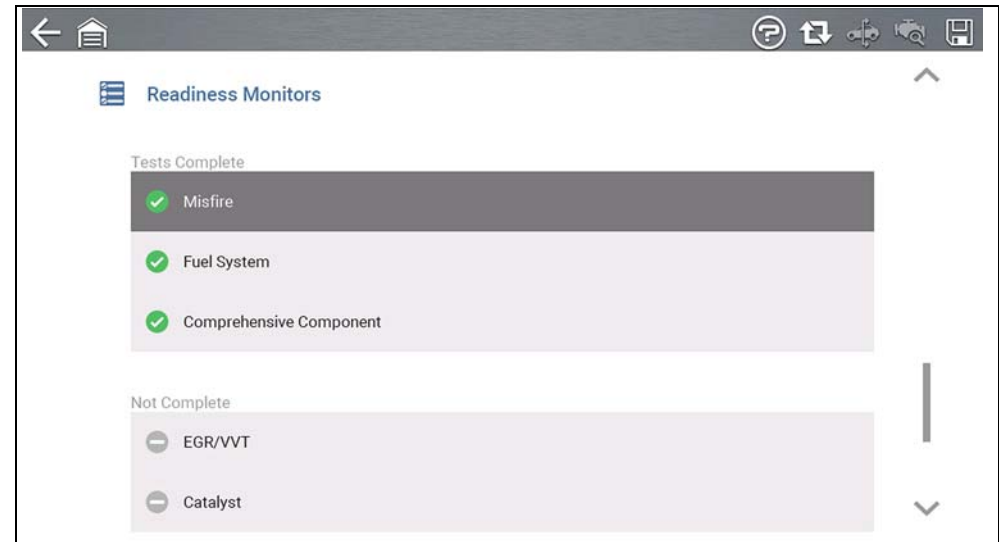

Figure 5-9



## 5.2 Vehicle System Report

After a code scan is completed the results of the scan are automatically configured into a Vehicle System Report that is uploaded and saved to your Snap-on Cloud account (if registered and connected). Report examples are shown in [Figure 5-1](#).

Using the Snap-on Cloud, the report can be printed, downloaded, attached to an e-mail or other social media app to share with others. For additional information on using the Snap-on Cloud, see [Snap-on Cloud on page 12](#).

### **i** NOTE

*Code scan reports are automatically saved each time a code scan is performed. The report is automatically uploaded to your Snap-on Cloud account, if registered and Wi-Fi is connected.*

The code scan/vehicle system report includes:

- Basic vehicle information
- A list of the code scan results by system
- Individual system DTCs with a brief description
- Global OBD codes
- Readiness monitor test status

### 5.2.1 Printing the Vehicle System Report

Use the Snap-on Cloud to print the vehicle system report from your PC or mobile device, see [Snap-on Cloud on page 12](#).

The vehicle system report can also be customized and printed using ShopStream Connect - See [ShopStream Connect™ \(Connecting to your PC\) on page 13](#).



## Introduction

Intelligent Diagnostics saves you time by providing access to code related data, information, and tests, all from one screen. It allows you to quickly find TSB's, smart data PID lists, out-of-range PIDs, functional tests, Sure Track Top Repairs Graph and Real Fixes, and more all at a glance.

In addition, you can directly access all (not just code related) PIDs and functional tests from one place, as compared to accessing them separately through the individual system menus.

## Wi-Fi Required



Wi-Fi connection is required to use this application. See [Wi-Fi Connection / Troubleshooting](#) on page 77.

## 6.1 Demonstration



Selecting the **Help icon** ([Figure 6-1](#)), starts a Intelligent Diagnostics slideshow demonstration describing the basic features of Intelligent Diagnostics.



Figure 6-1

Demonstration example screens are shown in [Figure 6-2](#).



Figure 6-2

## 6.2 Accessing Intelligent Diagnostics

To access Intelligent Diagnostics, you must:

- have authorized access. Contact your sales representative for information.
- have a Wi-Fi connection. For Wi-Fi setup and connection see, [Wi-Fi Connection / Troubleshooting](#) on page 77.

### Navigation

**Home Screen:** **Scanner** (Vehicle Identification) > (Vehicle System Menu) > (Vehicle System Main Menu) > (Codes Menu) > (Code Results) **Diagnose Icon**

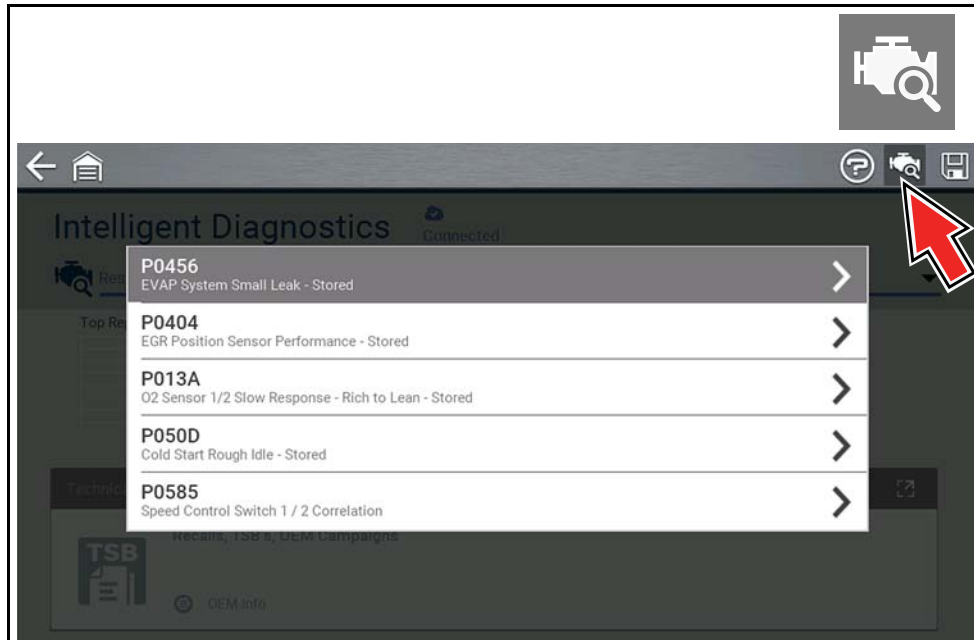

Figure 6-3

## 6.3 Main Menu

Intelligent Diagnostics functions are contained in a common multi-card main menu ([Figure 6-4](#)). Card functions are described in the following sections.

Intelligent Diagnostics and Scanner share some common functions. Cross references are used in the following sections for the applicable common information.

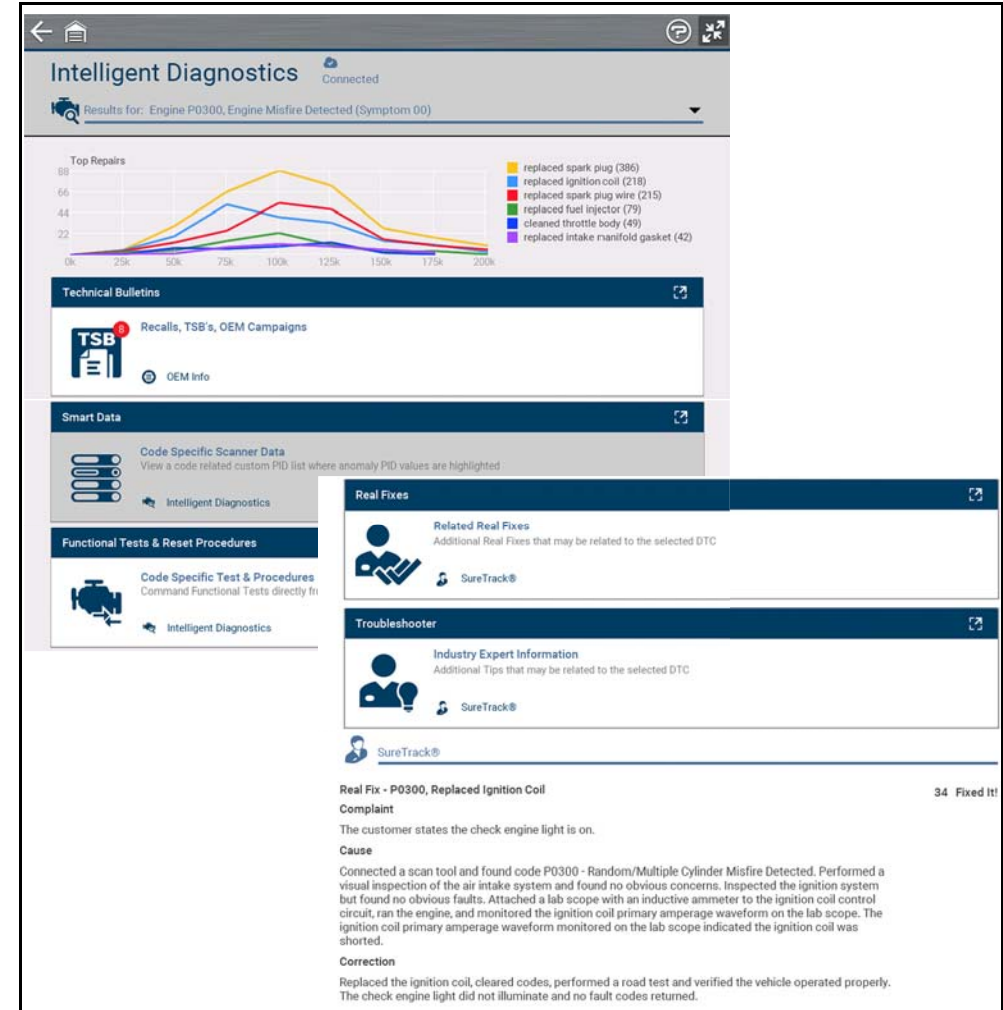

Figure 6-4

## 6.4 Wi-Fi Status Indicator

The cloud icon indicates Wi-Fi connection status (*Figure 6-4*). This icon is also used to indicate Intelligent Diagnostics service expiration. The icon will change red in color and display “Expired” when your service has expired.

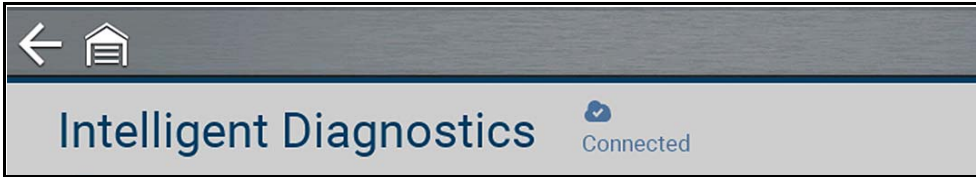

Figure 6-5

## 6.5 Code Results Dropdown Menu

The Code Results Dropdown menu allows you to quickly choose any of the scanned codes from the code results list. **Select a code to view related information about that code within Intelligent Diagnostics.**

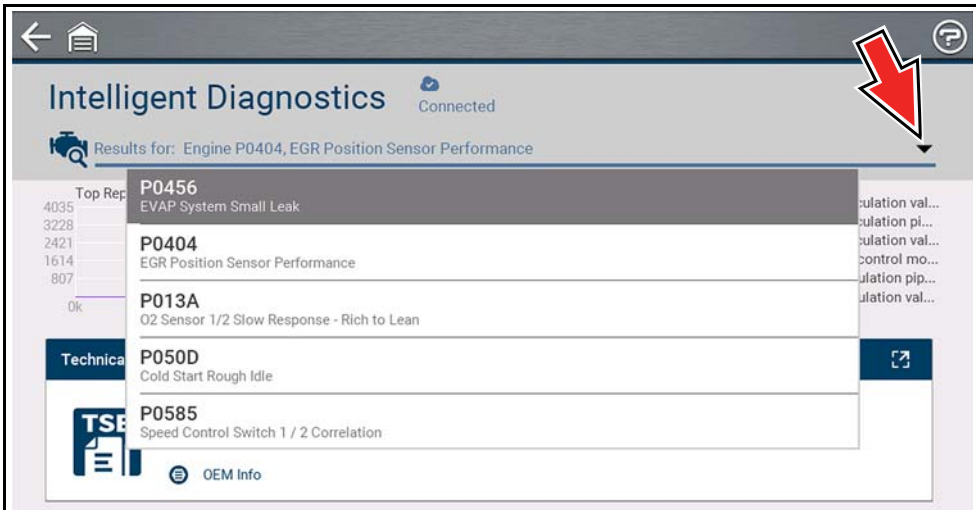

Figure 6-6

## 6.6 Top Repairs Graph

The Top Repairs Graph (*Figure 6-7*) shows the most common verified fixes and procedures for the selected code.

**Example** - In the graph shown below, the most common fix for the code was replacing the intake manifold gasket. This fix occurred 413 times, with the most occurrences (85) at 100k miles in vehicles with up to 200k miles.

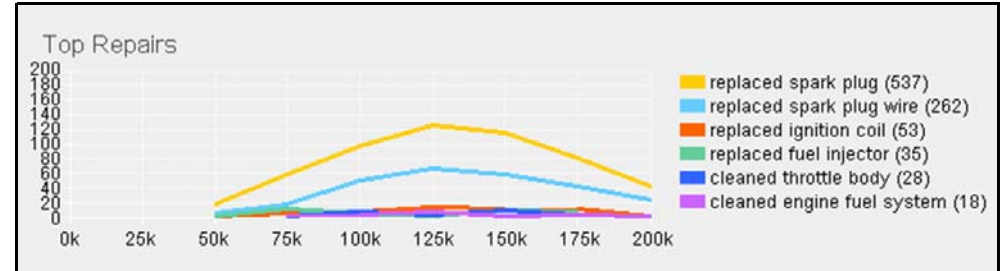

Figure 6-7

Depending on the information available, the graph may also include probable causes. See example in *Figure 6-8* “cleaned mass airflow sensor”.

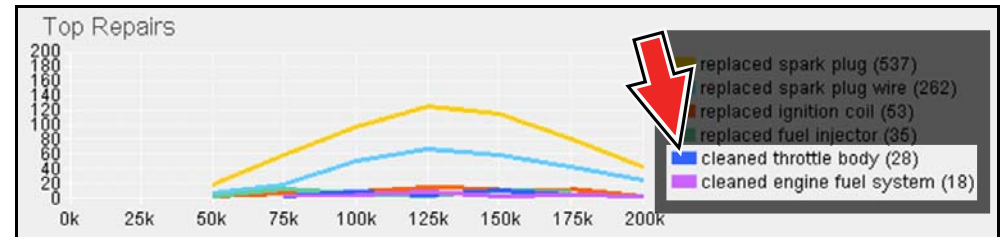

Figure 6-8

Select the Expand/Contract icon from the toolbar to change (toggle) the Top Repairs display mode. *Figure 6-9*.

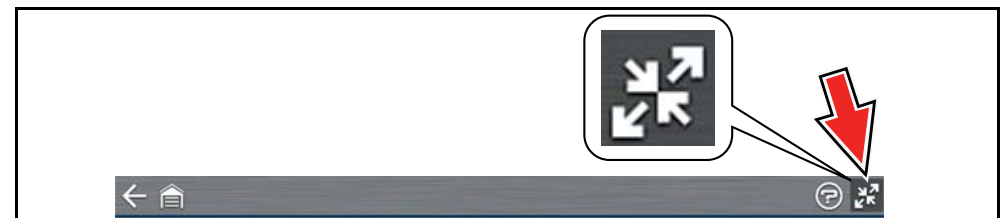

Figure 6-9

## 6.7 Technical Bulletins (OEM Information)

The Technical Bulletins card (*Figure 6-10*) provides a quick link to available OEM Recall, TSB and Campaign information that is code related.

- A red icon (*Figure 6-10*) indicates the total number of Recalls, TSBs, and OEM Campaigns that have been found.

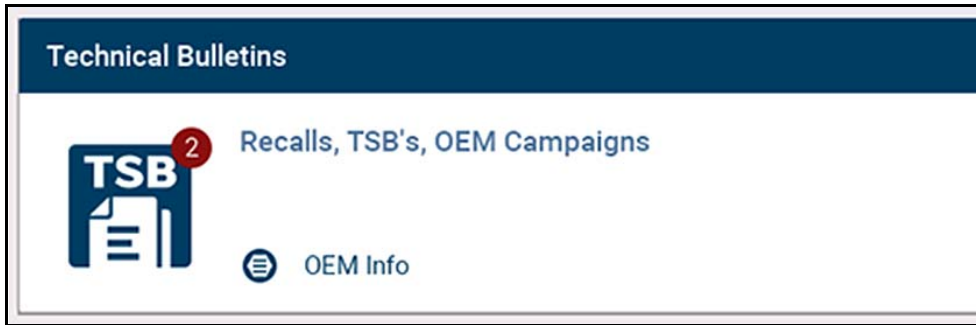

Figure 6-10

Select a topic from the list (*Figure 6-11*) to view detailed information on the topic (*Figure 6-12*).

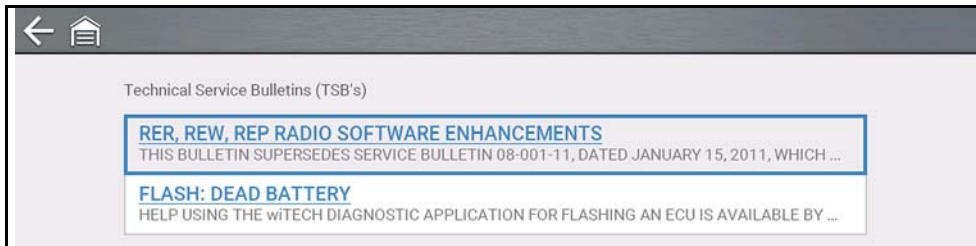

Figure 6-11

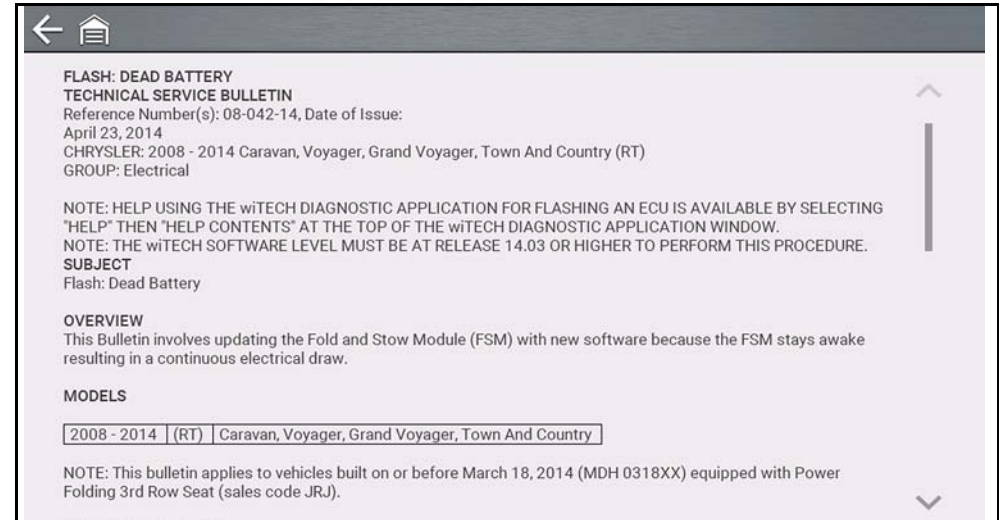

Figure 6-12

## 6.8 Smart Data

Smart Data automatically configures the data list to only show PIDs related to the selected code. Non-related PIDs are filtered out, to save you time. In addition, it highlights PIDs that are out of expected range.

As an added troubleshooting feature, you can also directly access all (not just code related) PIDs from one place, as compared to accessing them separately through the individual system menus.

### IMPORTANT

*Smart Data works best when the vehicle is idling at operating temperature with no load present. Always refer to OEM service information for specific PID range limit information.*

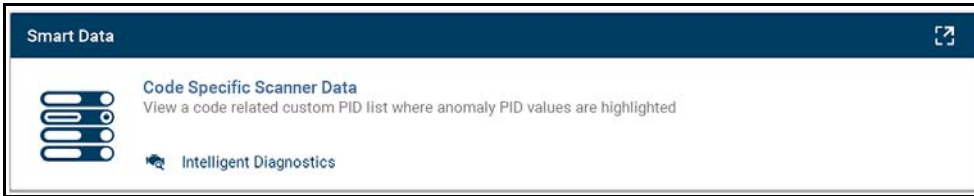

Figure 6-13

### PID List View (Figure 6-14)

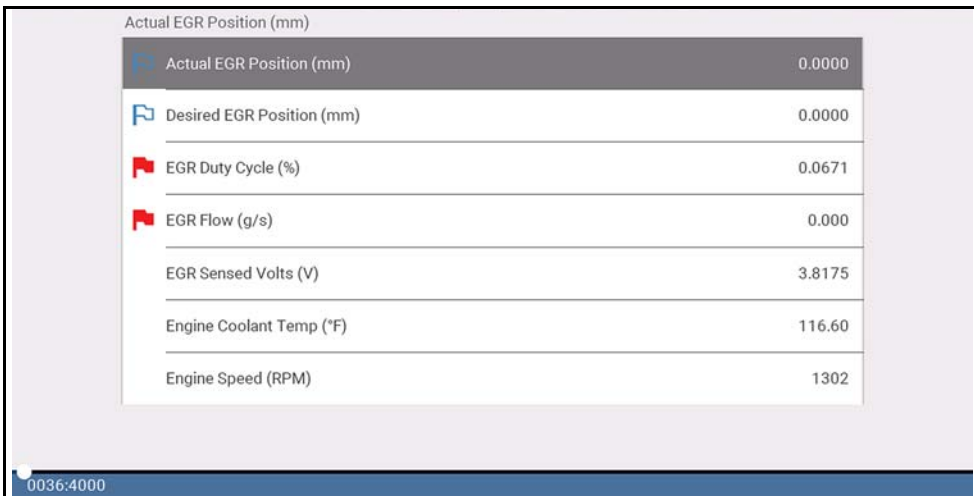

Figure 6-14

### PID Graph View (Figure 6-15).

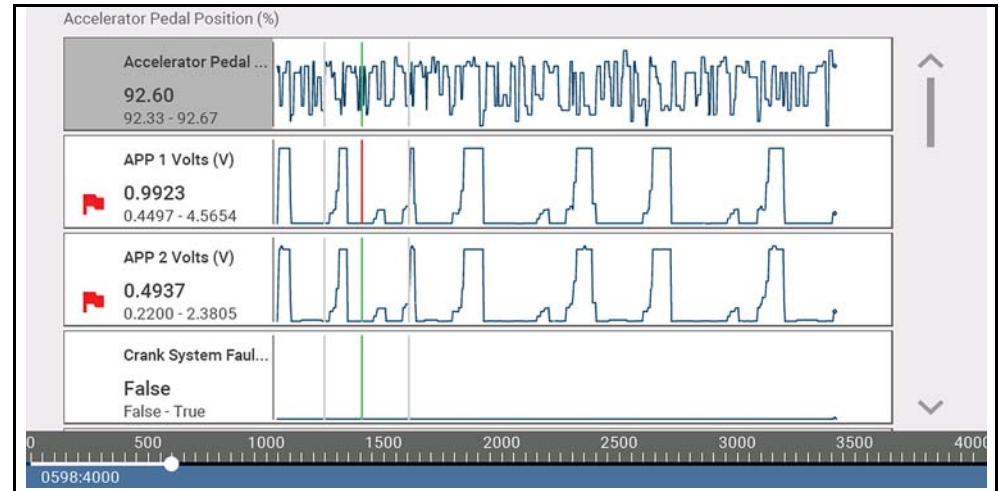

Figure 6-15

Selecting the **Back** icon opens the Smart Data main menu (Figure 6-16), which includes additional data list options (bottom of screen).

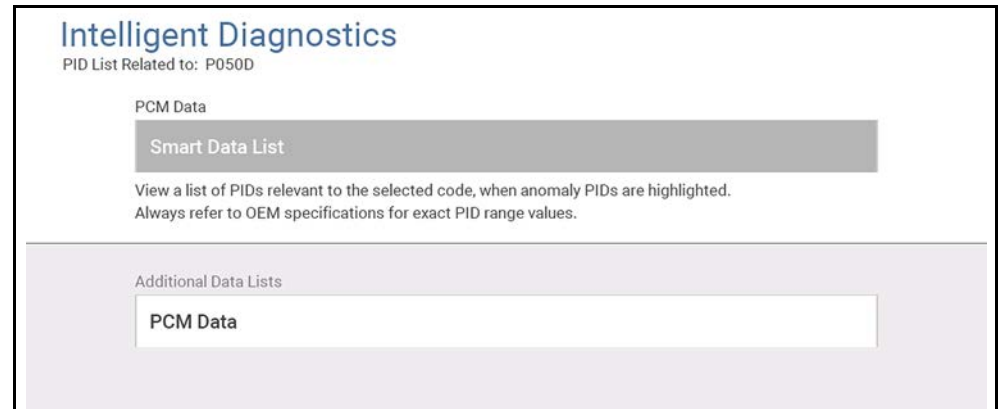



Figure 6-16



## 6.8.1 About Smart Data PIDs

### Features and operation of Smart Data PIDs:

- Any PID with a flag displayed has been preset and prearmed.
  - A red flag  indicates the PID trigger has been activated and is operating out of range.
  - A blue outlined flag indicates the PID is armed, and operating within its limits (trigger not activated).
- PID trigger points (upper/lower value limits) are automatically set using known-good upper/lower limit values.
  - **Note** - Upper/lower limit lines are not displayed on the graph, and values are not displayed in settings.
- Smart Data PID triggers can be (overridden) set manually, see [Using Triggers on page 35](#) for instructions.
  - **Note** - Manually setting trigger values will override the preconfigured Smart Data values.
  - **Note** - Manually set triggers will display upper and lower trigger limit lines in the graph.

When a trigger is activated:

- Data collection continues briefly after the trigger point, then pauses as the Scanner captures a recording of the data. Data is saved leading up to and just past the trigger point.
- An audible alarm is sounded
- A message displays indicating a data file was saved.
- Data collection continues.
- The activated PID trigger is disarmed. **Note** - if a different PID trigger is activated subsequently, an additional data file will be recorded.
- A red cursor line is displayed on the graph ([Figure 6-17](#)) of the PID with the activated trigger to indicate where the trigger occurred.
- A green cursor line is displayed on all the other PID graphs to indicate their relationship to where the trigger occurred.
- A gray cursor line is displayed to indicate the point at which the data was paused to save the data file.

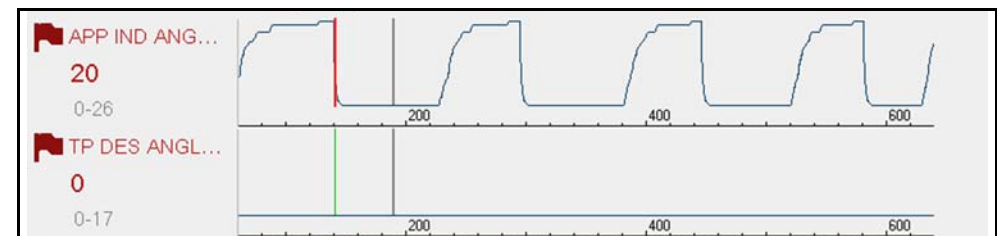

Figure 6-17 Triggers activated





## 6.9 Functional Tests and Reset Procedures

Functional Tests and Reset Procedures ([Figure 6-18](#)) provides access to supported code related bi-directional tests (to verify component operation) and reset procedures (to complete the repair).

In addition, you can directly access all (not just code related) functional tests from one place, as compared to accessing them separately through the individual system menus.

For additional information see [Functional Tests](#) on page 38.

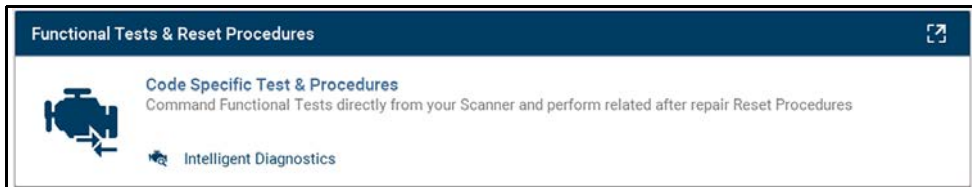

Figure 6-18

The upper list provides Functional Tests and Reset options related to the selected code. The lower list may provide additional Functional Tests and Reset options that are not code related, but are vehicle specific and may be useful in troubleshooting or validating repairs.

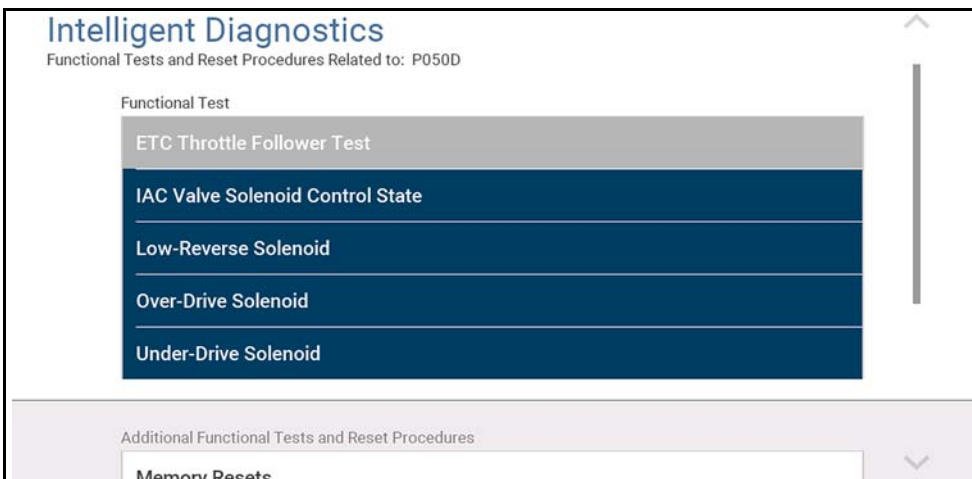

Figure 6-19

## 6.10 Real Fixes

The Real Fix displayed on the Main Menu ([Figure 6-20](#)) is the most common to date. The information is displayed in a Complaint - Cause - Correction format.

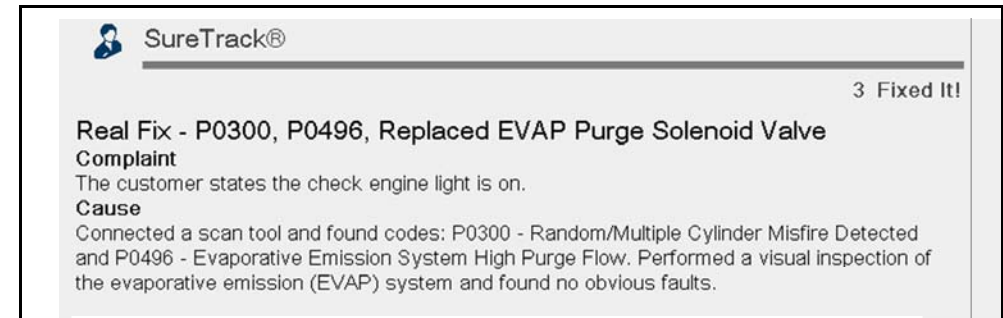

Figure 6-20

Real Fixes ([Figure 6-22](#)) provides a list of available code-related procedures, tests and repair tips (Real and Related Real Fixes) obtained from actual shop repairs.

Fixes may not be available for every vehicle and/or DTC.

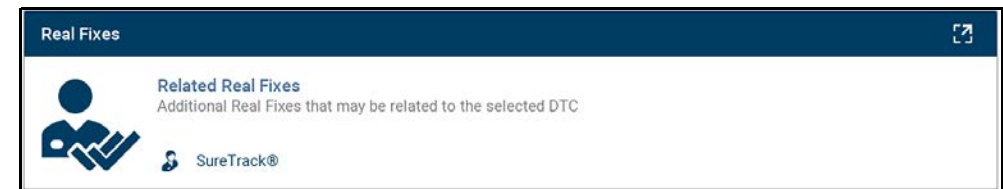

Figure 6-21

Select a **Related Real Fix** from the list ([Figure 6-22](#)) to view detailed information about the fix ([Figure 6-23](#)) in a Complaint - Cause - Correction format.



Figure 6-22



SureTrack®

---

Real Fix - P0404, Replaced Exhaust Gas Recirculation Valve

11510 Fixed It!

**Complaint**  
The customer states the check engine light is on.

**Cause**  
Connected a scan tool and found code P0404 - Exhaust Gas Recirculation "A" Control Circuit Range/Performance. At idle, monitored live scan tool data and observed the exhaust gas recirculation valve parameter was not within the specified range. Performed a road test while monitoring live scan tool data and observed the exhaust gas recirculation valve parameter was fixed. Performed an inspection of the exhaust gas recirculation system and detected no obvious faults. Removed the exhaust gas recirculation valve and a visual inspection revealed the pintle was damaged.

**Correction**  
Replaced the exhaust gas recirculation valve, cleared codes, performed a road test and verified the vehicle operated properly. The check engine light did not illuminate and no fault codes returned.

Figure 6-23

## 6.11 Troubleshooter

**Troubleshooter** (Figure 6-25) provides a list of available code-related tips gathered from industry professionals.

### **i** NOTE

*Troubleshooter Tips may not be available for every vehicle and/or DTC.*

Troubleshooter

**Industry Expert Information**

Additional Tips that may be related to the selected DTC

SureTrack®

Figure 6-24

Select a **Related Tip** from the list (Figure 6-25) to view the information (Figure 6-26).

Troubleshooter

**P0404**  
P0404: EGR Position Sensor Rationality Monitor State: Engine running. Code Set Condition: The ...

**P0404**  
P0404: EGR Position Sensor Performance Monitor State: The PCM performs two diagnostic ...

Figure 6-25

**Tip - P0404**

P0404: EGR Position Sensor Rationality Monitor State:  
Engine running.  
Code Set Condition:  
The EGR flow or valve movement is not what is expected. A rationality error has been detected from the EGR Close Position Performance. Two trip fault.  
Possible Causes:  
Excessive resistance in the egr sensor signal circuit  
Excessive resistance in the 5 volt supply circuit  
Excessive resistance in the egr solenoid control circuit  
Excessive resistance in the sensor ground circuit  
Egr solenoid ground circuit open  
Egr solenoid assembly  
PCM  
EBI (Tech Note):  
EGR position sensor is a 3 wire potentiometer similar to TPS. It is mounted on top of the EGR valve and measures pintle position.  
Use PID data to monitor EGR while driving

Figure 6-26



Quick Lookups provides access to vehicle manufacturer:

- Engine Oil Specifications and Reset Information
- Tire and Wheel Service Information and Reset Information

## Wi-Fi Required



Wi-Fi connection is required to use this application. See [Wi-Fi Connection / Troubleshooting](#) on page 77.

## Quick Links

- [Oil Specs and Resets](#) page 53
- [Tire and Wheel Service](#) page 56

## 7.1 Oil Specs and Resets

### Navigation

**Home Screen:** [Quick Lookups](#) > [Oil Specs and Resets](#)

The Oil Specs and Resets information service provides up-to-date OEM information on your diagnostic tool. Quick Lookups provides both OEM information and Scanner functions in one place.

Typical OEM information provided:

- Oil capacity and specifications
- Oil Service reset procedures and information
- Scanner Functional Resets

### NOTES

— *Oil Specs and Resets vehicle coverage is the same as the Scanner vehicle coverage.*

— *Not all vehicles may have on-board diagnostic tool reset capabilities, or have information available.*

— *To use the Oil Specs and Resets feature you must have authorized access, contact your sales representative for details.*

— *The diagnostic tool is equipped with the ability to connect to a Wi-Fi network, however the connection is solely dedicated to our Snap-on Information Service Network. Before you begin using an integrated Information Service you must connect to a wireless network. See [Wi-Fi Connection / Troubleshooting](#) on page 77 for instructions.*

— *If you experience a wireless network connection loss, Oil Specs and Resets information will not refresh and/or may cause the function to stop. To continue use, you must re-establish your Internet connection.*

— *Performance may vary depending on your wireless network equipment and ISP.*



## 7.1.1 Operation

There are two methods to access **Oil Specs and Resets**:

1. From the Home screen - select the **Quick Lookups** icon, then select Oil Specs and Resets.
2. From within a current Scanner session - select **Oil Specs and Resets** from the System menu (*Figure 7-1*).

Follow the screen prompts to ID the vehicle, then select an option:

- Perform a service interval reset using the diagnostic tool.
- View OEM service reset instructions and related information.

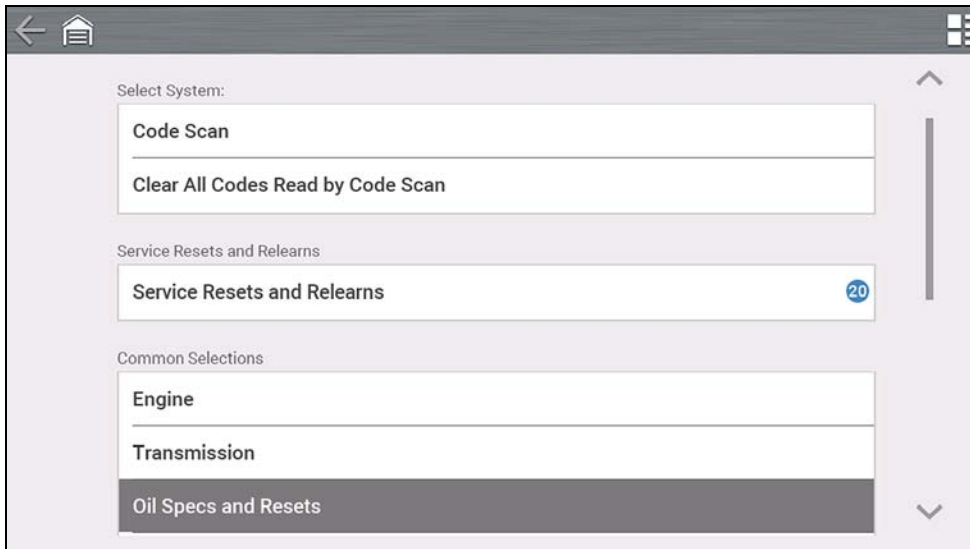

Figure 7-1

## 7.1.2 Fluid Capacity



Selecting the **Fluid Capacity** icon displays OEM recommended engine oil and capacity information (*Figure 7-2*).

Typical information may include:

- Vehicle application information
- Oil capacity specifications with or without oil filter
- Oil rating, weight and type
- Special notes

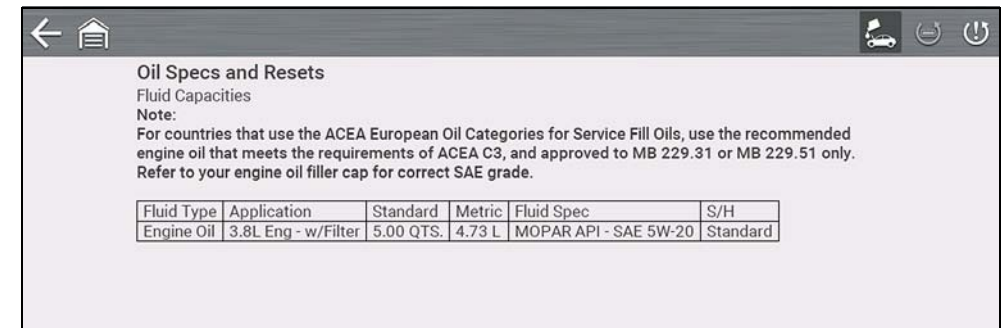

Figure 7-2



## 7.1.3 Functional Reset



Selecting the **Functional Reset** icon opens the service interval reset menu (within the Scanner function) for the selected vehicle, and includes functional resets for the oil service indicator and other supported resets.

Instructions may be provided, that are required to be performed before selecting or completing the reset function itself. Follow all instructions as written.

### NOTES

*Functional resets are not available for all vehicles, and will vary depending on vehicle support.*

*A “grayed out” or non-selectable icon indicates that functional resets are not available for the selected vehicle.*

*Service interval reset menus and selections, will vary by manufacturer.*

1. Select the **Functional Reset** icon.
2. Select the applicable menu option(s) to perform the functional reset.
3. Read and perform any instructions that are provided.
4. If applicable, once the reset has completed select **OK** or **Continue**.  
The following screen examples ([Figure 7-3](#)) illustrate typical indicator reset screens.

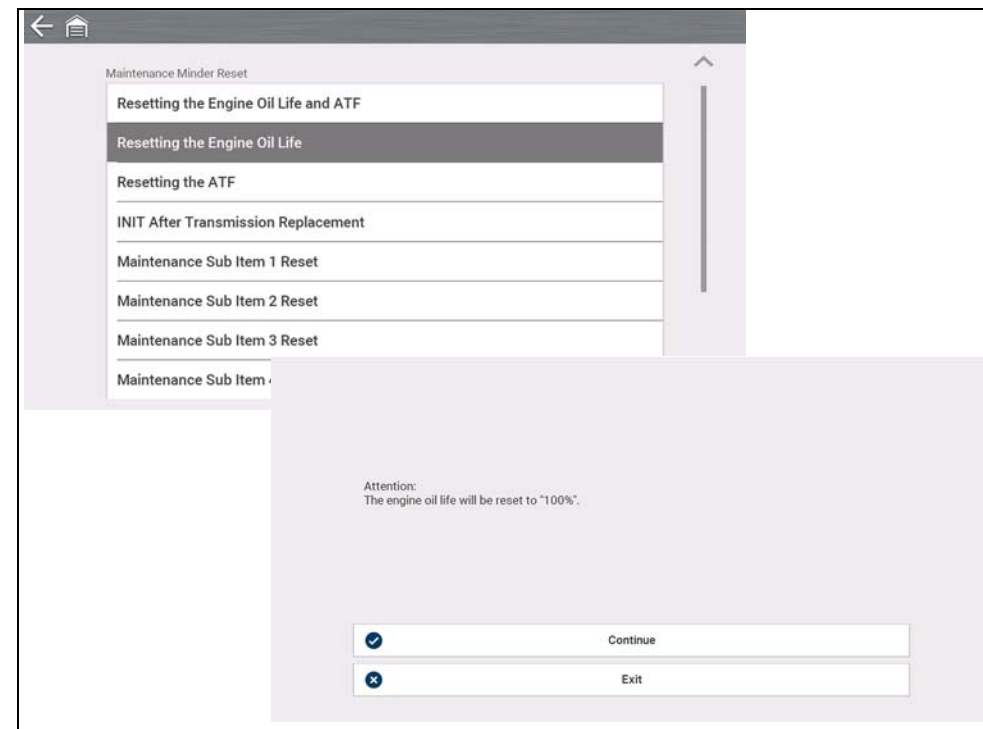

Figure 7-3

## 7.1.4 Reset Procedure



Selecting the **Reset Procedure** icon displays OEM oil service reset instructions.

Typical information may include:

- Step-by-step instructions for manually resetting the oil service reset indicator using on-board vehicle functionality (e.g. instrument cluster controls, accelerator pedal, information or media center controls, multi-function switch, etc.)
- Special notes, and/or instructions
- Theory of operation

The following are examples ([Figure 7-4](#)) of typical oil service reset instructions.

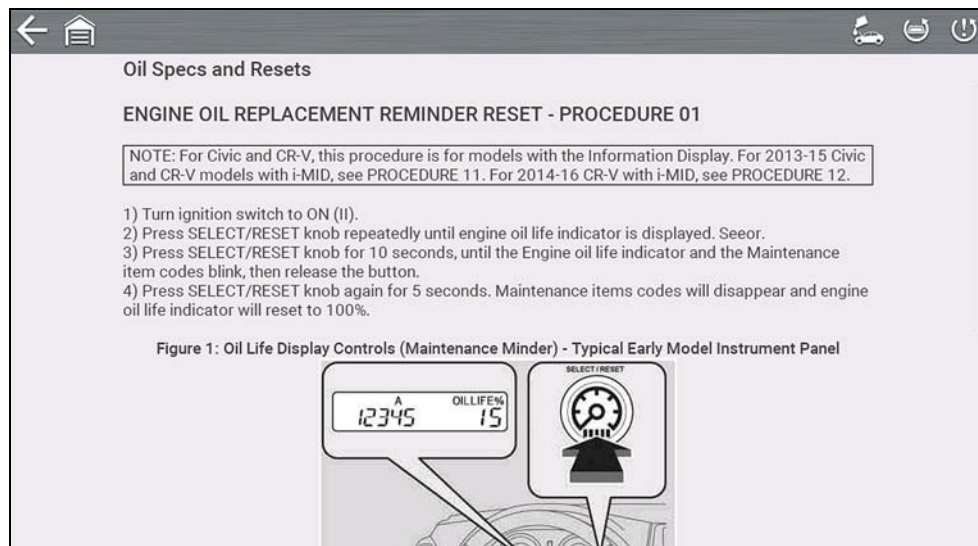

Figure 7-4

## 7.2 Tire and Wheel Service

### Navigation

**Home Screen:** Quick Lookups > Tire and Wheel Service

The Tire and Wheel Service Information Service provides up-to-date information on your diagnostic tool. This feature allows you quick access to the following information:

- Tire Pressure Monitoring System (TPMS) Indicator Reset Procedures
- TPMS Relearn Procedures
- Tire Pressure Sensor Removal/Installation Procedures
- Tire Fitment Specifications

The following may also be available when connected to a vehicle:

- View and Clear TPMS Related Codes
- View TPMS Related Data
- Perform TPMS Related Functional Tests
- View TPMS Troubleshooter Information

### NOTES

— Tire and Wheel Service vehicle coverage is the same as the Scanner vehicle coverage.

— Not all vehicles may have on-board diagnostic tool reset capabilities, or have information available.

— To use the Tire and Wheel Service feature you must have authorized access, contact your sales representative for details.

— The diagnostic tool is equipped with the ability to connect to a Wi-Fi network, however the connection is solely dedicated to our Snap-on Information Service Network. Before you begin using an integrated Information Service you must connect to a wireless network. See [Wi-Fi Connection / Troubleshooting](#) on page 77 for instructions.

— If you experience a wireless network connection loss, Tire and Wheel Service information will not refresh and/or may cause the function to stop. To continue use, you must re-establish your Internet connection.

— Performance may vary depending on your wireless network equipment and ISP.

## 7.2.1 Operation

There are two methods to access **Tire and Wheel Service**:

1. From the Home screen - select the **Quick Lookups** icon, then select **Tire and Wheel Service**.
2. From within a current Scanner session - select **Tire and Wheel Service** from the System menu (*Figure 7-5*).

Follow the screen prompts to ID the vehicle, then select an option.



Figure 7-5

## TPMS Indicator Reset



Selecting the **TPMS Indicator Reset** icon displays TPMS indicator reset instructions.

Typical information may include:

- Instructions for manually resetting the TPMS indicator using on-board vehicle functionality.
- Special notes, and/or instructions
- Theory of operation

The following example (*Figure 7-6*) shows typical TPMS indicator reset instructions.

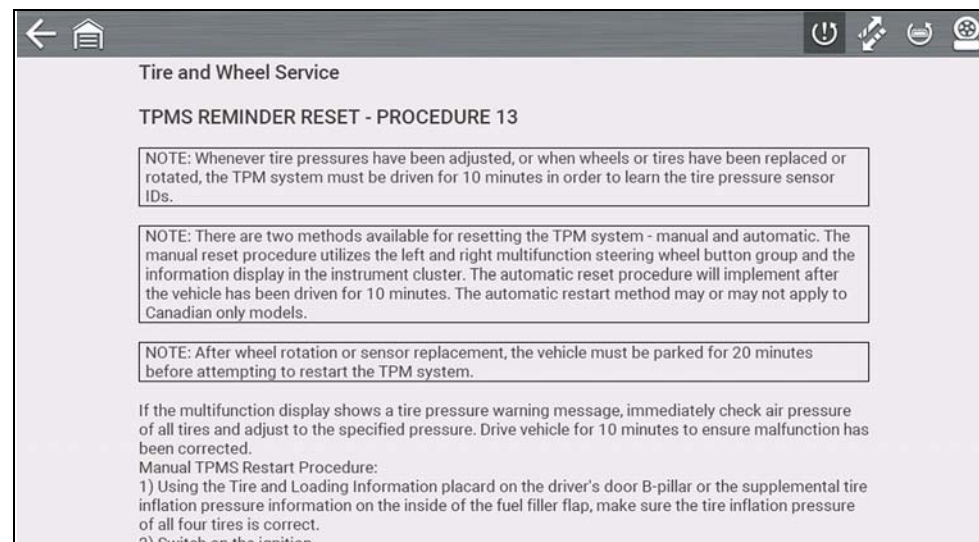

Figure 7-6



## TPMS Remove & Repair (TPMS Service)



Selecting the **Remove & Repair (TPMS Service)** icon displays TPMS service information.

Typical information may include:

- Removal and installation instructions.
- Relearn/enable procedures
- Diagnostic testing procedures
- Theory of operation

The following are examples (*Figure 7-7*) of typical TPMS service procedures.

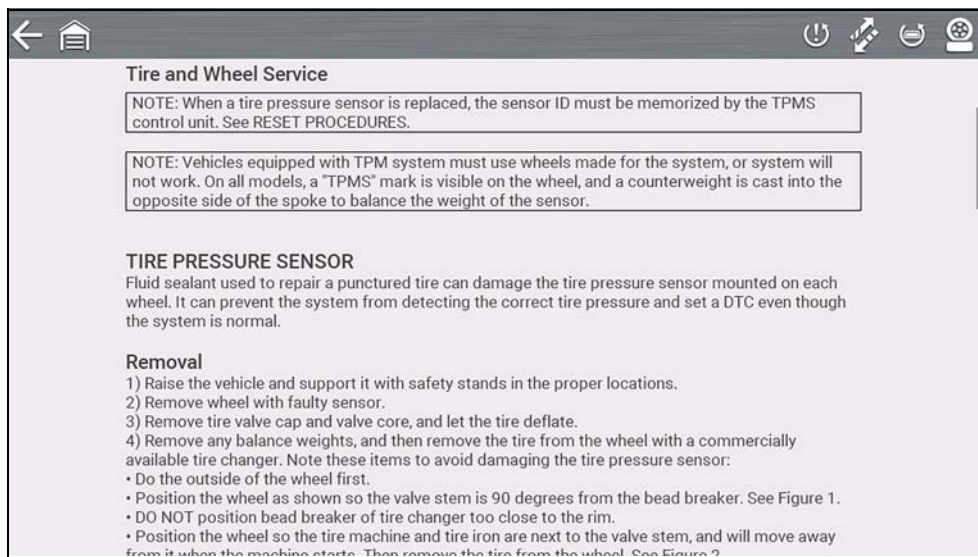

Figure 7-7

## Scanner Functions



Selecting the **Scanner Function** icon opens the TPMS Scanner test menu for the selected vehicle.

Options may include:

- View and Clear Codes
- View Data
- Perform TPMS Related Functional Tests/Resets
- View TPMS Troubleshooter Information

### IMPORTANT

**Functional test instructions may be provided, that are required to be performed before selecting or completing the function itself. Follow all instructions as written.**

### NOTES

*Scanner functions require connection and communication with the vehicle.*

*Functional tests/resets are not available for all vehicles, and will vary depending on vehicle support.*

*A “grayed out” or non-selectable icon indicates that functional resets/resets are not available for the selected vehicle.*

*Service test/reset menu titles will vary by manufacturer.*

The following screen examples (*Figure 7-8*) illustrate some typical TPMS functional test screens.



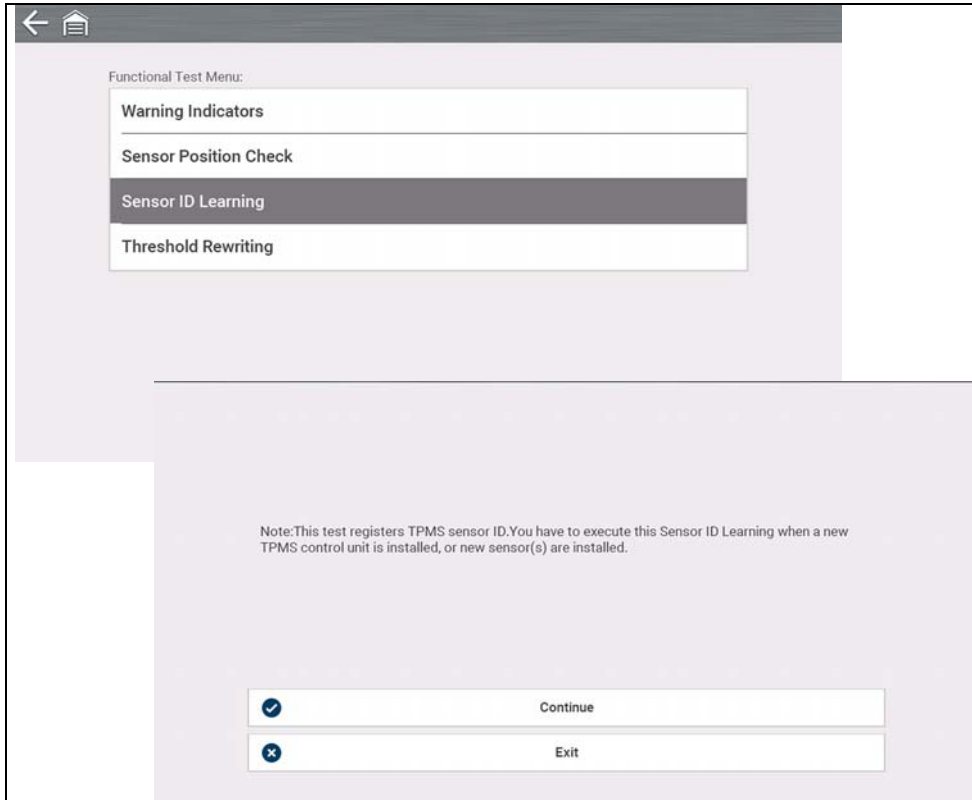

Figure 7-8

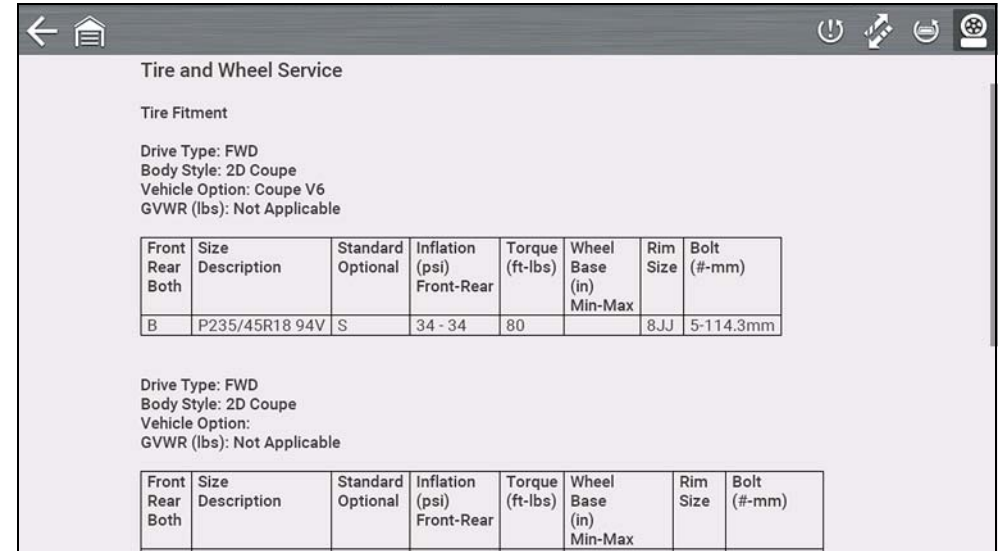

Figure 7-9

## Tire/Wheel Specifications (Fitment)



Selecting **Tire/Wheel Specifications** displays OEM tire and wheel specifications ([Figure 7-9](#)).

Typical information may include:

- Tire size and pressure
- Wheel hub stud size and lug torque
- Wheel size



Training and Support provides short videos on how to setup and get started using select features of your diagnostic tool.

For diagnostic tool training videos and information see the product website. See [Customer Support / Links](#) on page vi for website links.

## 8.1 Training and Support

### Navigation

**Home Screen:** [Training and Support](#)

The back arrow on the left side of the upper toolbar ([Figure 8-1](#)), or the “N” button can be used to stop playback and/or return to the main Training and Support menu.



Figure 8-1

### **i** NOTE

*The videos provided (at time of publishing) do not include audio, therefore the sound control in the upper right toolbar ([Figure 8-1](#)) is not functional.*

### 8.1.1 Setting up your Wi-Fi connection

Watch a short video tutorial on how to setup and turn on your diagnostic tool Wi-Fi. For additional information see, [Wi-Fi Connection / Troubleshooting](#) on page 77.



Figure 8-2



## 8.1.2 Setting up the Snap-on Cloud

Watch a short video tutorial on the basic setup and authorization steps required to get started using the Snap-on Cloud. For additional information see, [Snap-on Cloud on page 12](#).



Figure 8-3

## 8.1.3 Sharing a pre and post scan report (Code Scan Report)

Watch a short video tutorial on how to share a pre/post scan report using your Snap-on Cloud account.



Figure 8-4

## 8.1.4 Upgrading your device (Software Upgrades)

Watch a short video tutorial on how to download and install software upgrades for your diagnostic tool.



Figure 8-5





The **OBD-II/EOBD** function allows you to access “generic” OBD-II/EOBD data, and data for some OBD-II/EOBD vehicles that are not included in the Scanner function databases.

Generic OBD-II/EOBD data is limited to emission related diagnostics, and can be used for the following, and more:

- Checking and clearing emissions-related trouble codes
- Checking the cause of the malfunction indicator lamp (MIL)
- Checking readiness monitor status prior to emissions certification testing
- Viewing Freeze Frame data
- Checking oxygen sensor data
- Checking pending and permanent trouble codes
- Performing bi-directional tests
- Check the number of times each of the monitor tests have been completed
- Check misfire, EVAP, and catalyst monitoring data

## 9.1 OBD Direct

### Navigation

**Home Screen:** OBD-II/EOBD > OBD Direct

**OBD Direct** provides access to all available OBD-II /EOBD control system services. Menu options are described in the following sections.

### 9.1.1 Start Communication

#### Navigation

**Home Screen:** OBD-II/EOBD > OBD Direct > OBD Diagnose > Start Communication

Start Communication establishes communication with the vehicle, and then displays available OBD-II /EOBD services (*Figure 9-1*). Menu options are described in the following sections.

#### **i** NOTE

*All service modes are not supported by all vehicles, available modes and options will vary.*

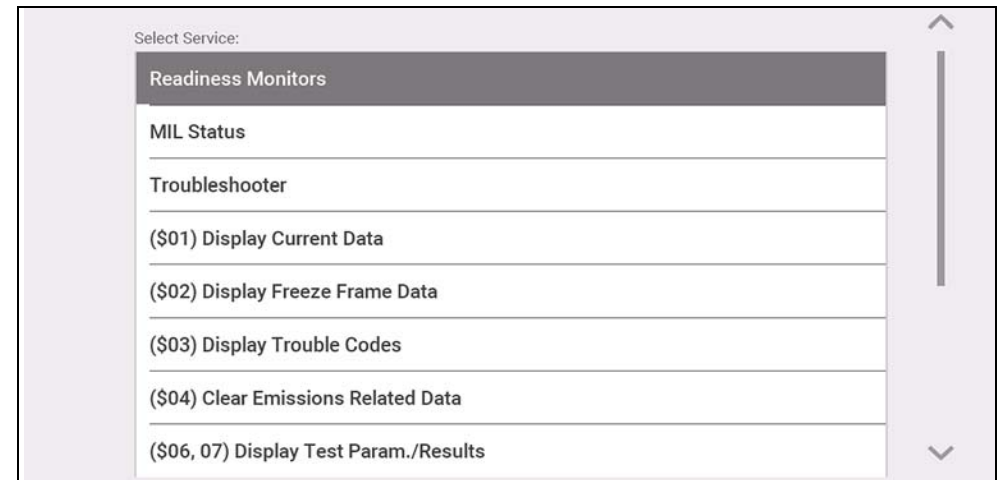

Figure 9-1



## Readiness Monitors

### Navigation

**Home Screen:** [OBD-II/EOBD > OBD Direct > OBD Diagnose > Start Communication > Readiness Monitors](#)

The readiness monitoring system is an OBD-II /EOBD control system that runs continuous and periodic integrity tests to check the status of emission-related controls and subsystems. Display options may include:

- **Monitors Complete Since DTC Cleared**—status of all monitors run since the last time ECM memory was erased.
- **Monitors Complete This Cycle**—status of the monitors that ran during the current drive cycle only.

Monitor Test reference indicators (*Figure 9-2*):

- **Green icon “✓” mark** - complete
- **Gray icon “—” mark** - not complete
- **Red icon “X” mark** - test not supported by vehicle

ID : \$	EB
✓ MISFIRE	TEST COMPLETE
✓ FUEL SYSTEM	TEST COMPLETE
✓ COMPONENTS	TEST COMPLETE
! CATALYST	NOT COMPLETE
✗ HEATED CATALYST	NOT SUPPORTED
! EVAPORATIVE SYSTEM	NOT COMPLETE
✗ SEC. AIR SYSTEM	NOT SUPPORTED

Figure 9-2

## MIL Status

### Navigation

**Home Screen:** [OBD-II/EOBD > OBD Direct > OBD Diagnose > Start Communication > MIL Status](#)

Mil Status checks the ECM commanded state on/off of the malfunction indicator lamp.

## Troubleshooter

### Navigation

**Home Screen:** [OBD-II/EOBD > OBD Direct > OBD Diagnose > Start Communication > Troubleshooter](#)

Troubleshooter provides reference information (e.g. code tips, parameter descriptions, and repair tips) from actual repairs.



**(\$01) Display Current Data**

**Navigation**

**Home Screen:** OBD-II/EOBD > OBD Direct > OBD Diagnose > Start Communication > (\$01) Display Current Data

This service displays current emission related PID descriptions and values.

ID:\$	E8
ENGINE SPEED(1/min)	2444
ABSOLUTE THROTTLE POSITION(%)	17.3
ABSOLUTE THROTTLE POSITION B(%)	17.3
RELATIVE THROTTLE POSITION(%)	7.1
COMMANDED THROTTLE ACT.CONTROL(%)	7.1
ACCELERATOR PEDAL POSITION D(%)	15.7
ACCELERATOR PEDAL POSITION E(%)	7.5

Figure 9-3

**(\$02) Display Freeze Frame Data**

**Navigation**

**Home Screen:** OBD-II/EOBD > OBD Direct > OBD Diagnose > Start Communication > (\$02) Display Freeze Frame Data

This service provides a “snapshot” of critical parameter values at the time an emission related DTC is set.

Typically the stored data frame is from the last DTC that occurred, however certain DTCs that have a greater impact on vehicle emissions will have a higher priority. In this situation, the freeze frame data for the DTC with the highest priority level will be retained.

**(\$03) Display Trouble Codes**

**Navigation**

**Home Screen:** OBD-II/EOBD > OBD Direct > OBD Diagnose > Start Communication > (\$03) Display Trouble Codes

This service displays a list of current emission related DTCs.

Select a code from the list below for code specific diagnostics	
P0115	Engine Coolant Temperature Sensor 1 Circuit
P0230	Fuel Pump Primary Circuit
P0350	Ignition Coil Primary/Secondary Circuit/Open
P0460	Fuel Level Sensor "A" Circuit

Figure 9-4

OBD-II/EOBD Codes have a priority according to their emission severity. The priority of the code determines the illumination of the MIL and the code erase procedure. Priority rankings vary across vehicle manufacturers, makes and models.



### (\$04) Clear Emissions Related Data

#### Navigation

**Home Screen:** [OBD-II/EOBD > OBD Direct > OBD Diagnose > Start Communication > \(\\$04\) Clear Emissions Related Data](#)

This service clears all emission related diagnostic data, such as DTCs, freeze frame data, and test results, from ECM memory.

#### IMPORTANT

*Clear Codes erases all stored data, including any enhanced codes and freeze frame information.*

### (\$05) Oxygen Sensor Monitoring

#### Navigation

**Home Screen:** [OBD-II/EOBD > OBD Direct > OBD Diagnose > Start Communication > \(\\$05\) Oxygen Sensor Monitoring](#)

This service provides access to the tests available for checking the integrity of the oxygen (O<sub>2</sub>) sensors. Making a selection displays all related O<sub>2</sub> sensor parameters for the specific test. The test identification (ID) displays at the top of the data list.

### (\$06) On-Board Monitored Systems

#### Navigation

**Home Screen:** [OBD-II/EOBD > OBD Direct > OBD Diagnose > Start Communication > \(\\$06, 07\) Display Test Param./Results > \(\\$06\) On-Board Monitored Systems](#)

This service provides access to monitored systems data. The available data is for specific systems and components that the on-board diagnostic system monitors continuously (e.g. misfires), or non-continuously (e.g. catalyst system).

### (\$07) DTCs Detected During Last Drive

#### Navigation

**Home Screen:** [OBD-II/EOBD > OBD Direct > OBD Diagnose > Start Communication > \(\\$06, 07\) Display Test Param./Results > \(\\$07\) DTCs Detected During Last Drive](#)

This service displays a list of “pending” or maturing DTCs. These are codes whose setting conditions were met during the last drive cycle, but need to be met on two or more consecutive drive cycles before the DTC actually sets.

#### NOTE

*Check pending codes to verify test results after a single drive cycle following a repair and code clear.*

- If a test failed during the drive cycle, the DTC associated with that test is reported. If the pending fault does not occur again within 40 to 80 warm-up cycles, the fault is automatically cleared from memory.
- Test results reported by this service do not necessarily indicate a faulty component or system. If test results indicate another failure after additional driving, then a DTC is set to indicate a faulty component or system, and the MIL is illuminated.

### (\$08) Request Control of On-board System

#### Navigation

**Home Screen:** [OBD-II/EOBD > OBD Direct > OBD Diagnose > Start Communication > \(\\$08\) Request Control of On-board System](#)

This service allows the diagnostic tool to control the operation of an on-board system, test, or component.





### (\$09) Read Vehicle Identification

#### Navigation

**Home Screen:** OBD-II/E OBD > OBD Direct > OBD Diagnose > Start Communication > (\$09) Read Vehicle Identification

This service displays vehicle-specific information, such as the vehicle identification number (VIN), the calibration identification, and the calibration verification number (CVN), of the vehicle.

### (\$09) In-use Performance Tracking

#### Navigation

**Home Screen:** OBD-II/E OBD > OBD Direct > OBD Diagnose > Start Communication > (\$09) In-use Performance Tracking

This service displays “In-use Performance Tracking” data. It is a record of the number of times each of the monitor tests have been completed.

### (\$0A) Display Permanent Trouble Codes

#### Navigation

**Home Screen:** OBD-II/E OBD > OBD Direct > OBD Diagnose > Start Communication > (\$0A) Display Permanent Trouble Codes

This service displays a record of any “permanent” codes. A permanent status DTC is one that was severe enough to illuminate the MIL at some point, but the MIL may not be on at the present time.

Whether the MIL was switched off by clearing codes or because the setting conditions did not repeat after a specified number of drive cycles, a record of the DTC is retained by the ECM. Permanent status codes automatically clear after repairs have been made and the related system monitor runs successfully.

### 9.1.2 Connector Information

#### Navigation

**Home Screen:** OBD-II/E OBD > OBD Direct > OBD Diagnose > Connector Information

This function provides access to vehicle diagnostic connector locations for most makes and models.

### 9.1.3 Manual Protocol Selection

#### Navigation

**Home Screen:** OBD-II/E OBD > OBD Direct > OBD Diagnose > Manual Protocol Selection

Typically the communication protocol is automatically detected when establishing communication with a vehicle, this service allows you to manually select a protocol, if automatic detection fails.

Communication protocol is a standardized way of transferring data between an ECM and a diagnostic tool. Global OBD may use the following communication protocols (*Figure 9-5*):

- ISO 15765-4 (CAN)
- ISO 27145 (WWHOBD CAN)
- ISO J1939 (CAN)
- ISO 9141-2 (K-LINE)
- SAE J1850 PWM (Pulse Width Modulation)
- SAE J1850 VPW (Variable Pulse Width)
- ISO 14230-4 (Keyword Protocol 2000)
- SAE J2284/ISO 15765-4 (CAN)

#### IMPORTANT

**Using unsupported OBD communication protocols may activate warning lights and can set network related faults. Only use the manual selection option when OBD protocol is already known.**

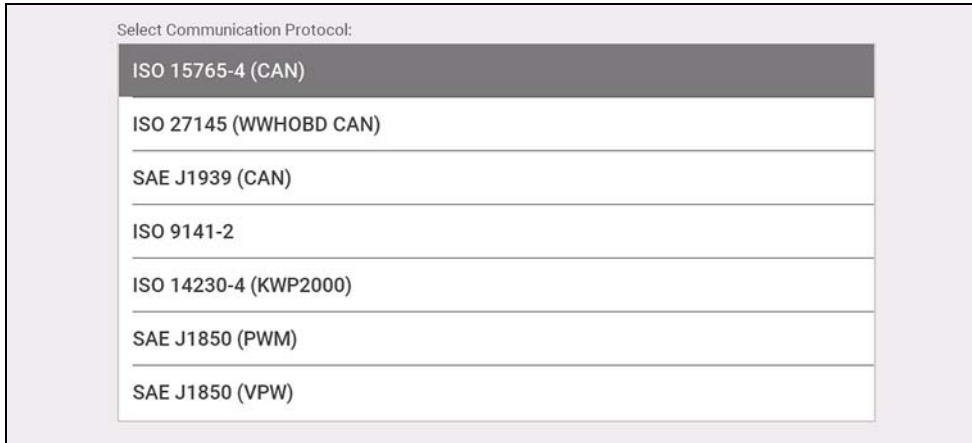

Figure 9-5

## 9.2 OBD Training Mode

### Navigation

**Home Screen:** OBD-II/EOBD > OBD Direct > OBD Training Mode

This function allows you to familiarize yourself with the capabilities of OBD-II/EOBD while navigating through menus without being connected to a vehicle.

## 9.3 OBD-II Health Check

### Navigation

**Home Screen:** OBD-II/EOBD > OBD Health Check

OBD-II Health Check allows you to quickly check readiness monitors, view emissions-related diagnostic trouble codes (DTCs) and more (Figure 9-6).

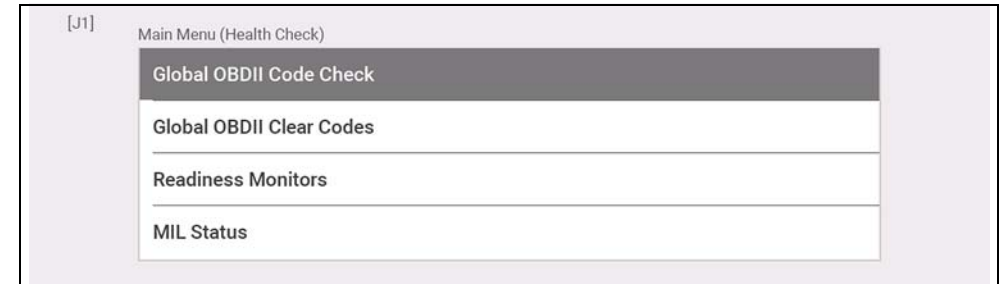

Figure 9-6

### 9.3.1 Global OBD-II Code Check

#### Navigation

**Home Screen:** OBD-II/EOBD > OBD Health Check > Global OBD-II Code Check

For Codes, see (\$03) *Display Trouble Codes* on page 65.

For Pending Codes, see (\$07) *DTCs Detected During Last Drive* on page 66.

### 9.3.2 Global OBD-II Clear Codes

#### Navigation

**Home Screen:** OBD-II/EOBD > OBD Health Check > Global OBD-II Clear Codes

See (\$04) *Clear Emissions Related Data* on page 66



### 9.3.3 Readiness Monitors

#### Navigation

**Home Screen:** [OBD-II/EOBD](#) > [OBD Health Check](#) > [Readiness Monitors](#)

---

See [Readiness Monitors](#) on page 64.

### 9.3.4 MIL Status

#### Navigation

**Home Screen:** [OBD-II/EOBD](#) > [OBD Health Check](#) > [MIL Status](#)

---

See [MIL Status](#) on page 64.



The **Previous Vehicles and Data** function allows you to reactivate previously identified vehicles for retesting, and access saved data files.

## 10.1 Vehicle History

### Navigation

**Home Screen:** Previous Vehicles and Data > Vehicle History

The last twenty-five vehicles identified are saved and available for retesting (*Figure 10-1*). The oldest vehicle record is deleted once twenty-five vehicles are saved.



Icons	
	<b>Activate Vehicle</b> - Select a previously identified vehicle ( <i>Figure 10-1</i> )
	<b>Delete</b> - Deletes selected attachment from a vehicle record, or the vehicle from history
	<b>Search</b> - Lists associated attachments for the selected vehicle (e.g. screen captures, code scans, data files, etc)



Figure 10-1

## 10.2 Saved Data

### Navigation

**Home Screen:** [Previous Vehicles and Data > Saved Data](#)

Exit vehicle communication before opening data files. Select a file to view it. The most recent files are listed first.

- **All Saved Data** - Lists all saved files ([Figure 10-2](#))
- **Screenshots** - Lists all saved screenshot files
- **Scanner** - Lists all saved scanner data files

### NOTE

A maximum of 50 files are displayed. To view all (if more than 50) files stored, transfer the files to a PC and use ShopStream Connect. See [Connect-to-PC \(File Transfer\)](#) on page 73 for additional information.

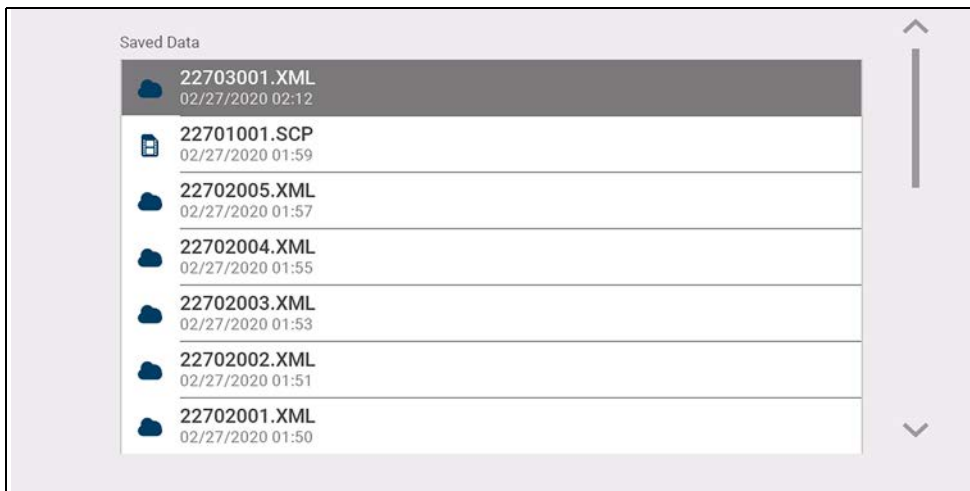

Figure 10-2

### 10.2.1 Viewing /Printing Saved Codes and Code Scan Results

Code scans and single system code results are saved as (.XML) files, and can be selected from the All Saved Data list or Scanner list ([Figure 10-2](#)).

To print:

- Transfer the files to ShopStream Connect, or
- Print from the Snap-on Cloud (if connected and authorized)

## 10.3 Delete Saved Data

### Navigation

**Home Screen:** [Previous Vehicles and Data > Delete Saved Data](#)



Select the file(s) to be permanently deleted, then select the **Delete** icon.



Use the **List** icon to select and deselect all files.



Figure 10-3



The **Tools** function allows you to configure diagnostic tool settings to your preferences.

## Quick Links

- [Tools Main Menu](#) page 72
- [Connect-to-PC \(File Transfer\)](#) page 73
- [Get Connected](#) page 73
- [Configure Shortcut Key](#) page 73
- [System Information](#) page 73
- [Brightness](#) page 74
- [Color Theme](#) page 74
- [High Contrast Toolbar](#) page 74
- [Font Type](#) page 74
- [Backlight Time](#) page 74
- [Time Zone](#) page 75
- [Clock Settings](#) page 75
- [Daylight Savings Time](#) page 75
- [24 Hour Format](#) page 75
- [Date Format](#) page 74
- [Configure Wi-Fi](#) page 76
- [Auto VIN](#) page 75
- [Code Scan Generics](#) page 75
- [Configure Units](#) page 76

## 11.1 Tools Main Menu

### Navigation

**Home Screen:** [Tools](#)

The main Tools menu includes multiple sub-menus and settings, which are described throughout this section.

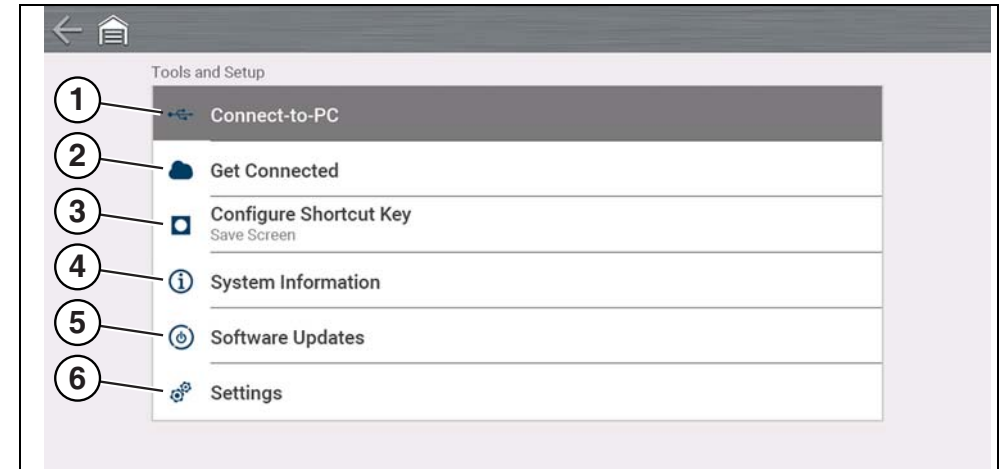

Figure 11-1

- 1— [Connect-to-PC \(File Transfer\)](#) on page 73
- 2— [Get Connected](#) on page 73
- 3— [Configure Shortcut Key](#) on page 73
- 4— [System Information](#) on page 73
- 5— [Software Updates](#) on page 73
- 6— [Settings](#) on page 74



## 11.2 Connect-to-PC (File Transfer)

### Navigation

**Home Screen:** [Tools > Connect to PC](#)

**Connect-to-PC** allows you to connect to your PC as an external drive, giving you the ability to transfer saved data files (using Windows® File Explorer) from your diagnostic tool to your PC.

Connect the supplied USB cable to the diagnostic tool and PC, then select **Connect-to-PC**.

### NOTE

*An alternative method of connecting your diagnostic tool to your PC is to use the companion application ShopStream Connect™ (SSC). SSC is a free application you install on your PC allowing you to view, print and save data files on your PC. See [ShopStream Connect™ \(Connecting to your PC\)](#) on page 13.*

## 11.3 Get Connected

### Navigation

**Home Screen:** [Tools > Get Connected](#)

**Get Connected** displays the diagnostic tool serial number, PIN and Code needed for Snap-on Cloud registration. See [Snap-on Cloud](#) on page 12 for instructions.

## 11.4 Configure Shortcut Key

### Navigation

**Home Screen:** [Tools > Configure Shortcut Key](#)

**Configure Shortcut Key** allows you to assign the function of the **Shortcut** button. Select an option to set the function:

- **Brightness**—opens the brightness setting

- **Save Screen**—saves a bitmap image of the visible screen.
- **Save Movie**—save PID data to a file
- **Show Shortcut Menu**—opens the Shortcut menu.

## 11.5 System Information

### Navigation

**Home Screen:** [Tools > System Information](#)

**System Information** displays various software and product information, such as the software version and serial number of the diagnostic tool.

## 11.6 Software Updates

### Wi-Fi Required



Wi-Fi connection is required to use this application. See [Wi-Fi Connection / Troubleshooting](#) on page 77.

### Navigation

**Home Screen:** [Tools > Software Updates](#)

**Software Updates** allows you to directly install software updates for your diagnostic tool. Follow the screen prompts to download and install updates. Also see the video tutorial information [Upgrading your device \(Software Upgrades\)](#) on page 61.



# 11.7 Settings

## Navigation

Home Screen: [Tools > Settings](#)

Settings provides the following sub-menus:

- [System Settings \(Display, Date & Time\)](#) on page 74
- [Configure Wi-Fi](#) on page 76
- [Configure Scanner](#) on page 75
- [Configure Units](#) on page 76

## 11.7.1 System Settings (Display, Date & Time)

System Settings provides sub-menus for various Display and Date and Time related settings. Descriptions are provided in the following sections.

## Navigation

Home Screen: [Tools > Settings > System Settings](#)

## Brightness

## Navigation

Home Screen: [Tools > Settings > System Settings > Display > Brightness](#)

Brightness allows you to adjust brightness of the display back lighting.

## Color Theme

## Navigation

Home Screen: [Tools > Settings > System Settings > Display > Color Theme](#)

Color Theme allows you to select:

- **Day Theme** (white screen background)
- **Night Theme** (black screen background)

## High Contrast Toolbar

## Navigation

Home Screen: [Tools > Settings > System Settings > Display > High Contrast Toolbar](#)

High Contrast Toolbar allows you to select:

- **Light** - (lighter background, darker icons)
- **Dark** - (darker background, lighter icons)

## Font Type

## Navigation

Home Screen: [Tools > Settings > System Settings > Display > Font Type](#)

Font Type allows you to select **Normal** or **Bold** font for the display.

## Backlight Time

## Navigation

Home Screen: [Tools > Settings > System Settings > Display > Backlight Time](#)

Backlight Time allows you to set the inactivity backlight time (i.e. Always on, or off after 15, 30, 45, 60 seconds.)

## Date Format

## Navigation

Home Screen: [Tools > Settings > System Settings > Date & Time > Date Format](#)

Date Format allows you to set the date display format.

- **(MM\_DD\_YYYY)**—Month, Day, Year
- **(DD\_MM\_YYYY)**—Day, Month, Year



- (YYYY\_MM\_DD)—Year, Month, Day

## Clock Settings

### Navigation

**Home Screen:** [Tools](#) > [Settings](#) > [System Settings](#) > [Date & Time](#) > [Clock Settings](#)

**Clock Settings** allows you to set the internal clock time.

## Time Zone

### Navigation

**Home Screen:** [Tools](#) > [Settings](#) > [System Settings](#) > [Date & Time](#) > [Time Zone](#)

**Time Zone** allows you to set the internal clock time zone.

## Daylight Savings Time

### Navigation

**Home Screen:** [Tools](#) > [Settings](#) > [System Settings](#) > [Date & Time](#) > [Daylight Savings Time](#)

**Daylight Savings Time** allows you to adjust the internal clock for daylight savings time.

## 24 Hour Format

### Navigation

**Home Screen:** [Tools](#) > [Settings](#) > [System Settings](#) > [Date & Time](#) > [24 Hour Format](#)

**24 Hour Format** allows you to set the internal clock format to either 12 or 24 hour.

## 11.7.2 Configure Scanner

### Navigation

**Home Screen:** [Tools](#) > [Settings](#) > [System Settings](#) > [Display](#) > [Brightness](#)

**Brightness** allows you to adjust brightness of the display back lighting.

## Graph Scale

### Navigation

**Home Screen:** [Tools](#) > [Settings](#) > [Configure Scanner](#) > [Graph Scale](#)

**Graph Scale** allows you to toggle the scales (On/Off) within Scanner. Scales are the graduations and values that display on the horizontal axis at the base of the parameter graphs. The waveform fills the entire graph area with scales switched off.

## Auto VIN

### Navigation

**Home Screen:** [Tools](#) > [Settings](#) > [Configure Scanner](#) > [Auto VIN](#)

**Auto VIN** allows you to turn (On/Off) the Instant Vehicle Identification feature.

## Code Scan Generics

### Navigation

**Home Screen:** [Tools](#) > [Settings](#) > [Configure Scanner](#) > [Code Scan Generics](#)

**Code Scan Generics** allows you to turn (On/Off) the scanning of OBD-II codes and monitors for Code Scan.



## 11.7.3 Configure Wi-Fi

### Navigation

**Home Screen:** [Tools](#) > [Settings](#) > [Configure Wi-Fi](#)

**Configure W-Fi** allows you to turn (On/Off) Wi-Fi, and configure Wi-Fi settings, see [Wi-Fi Connection / Troubleshooting](#) on page 77.

## 11.7.4 Configure Units

### Navigation

**Home Screen:** [Tools](#) > [Settings](#) > [Configure Units](#)

**Configure Units** allows you to display either US customary or metric units of measure.

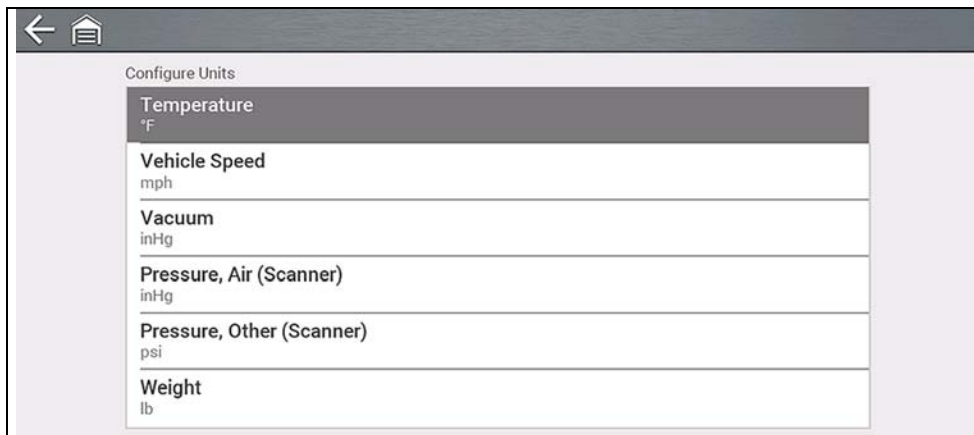

Figure 11-2



## Wi-Fi Required





A Wi-Fi connection is required to use various diagnostic tool features, (e.g. Intelligent Diagnostics and the Snap-on Cloud). It is recommended that you keep Wi-Fi turned on and connected during operation to ensure you have access to the latest diagnostic information and updates.

## 12.1 Checking if Wi-Fi is On and Connected

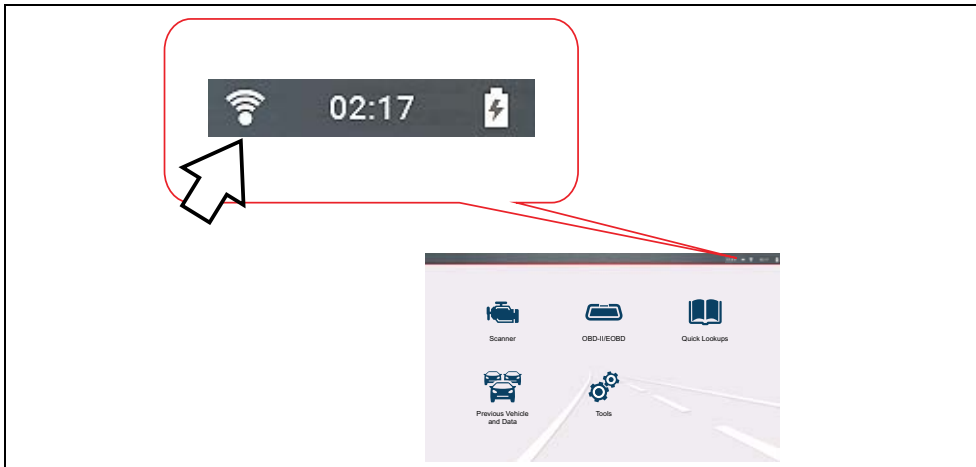
The Wi-Fi indicator is displayed in the title bar when Wi-Fi is on.



1 to 3 solid bars - Wi-Fi is on and connected to a network. Three bars indicates maximum strength signal.

	Flashing with “?” mark - Wi-Fi is on, but not connected. See <a href="#">Wi-Fi Troubleshooting and Status Messages</a> on page 79.
	No bars - No signal / out of range.

## 12.2 Turning Wi-Fi On and Connecting to a Network

### Navigation

Home Screen: [Tools](#) > [Settings](#) > [Configure Wi-Fi](#)

- To turn Wi-Fi on/off, select the **Wi-Fi power** icon ([Figure 12-1](#)).

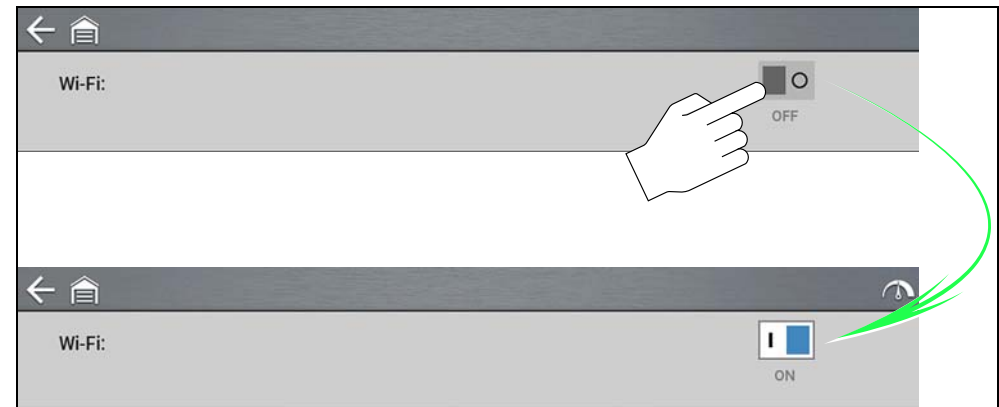

Figure 12-1



- To connect, select your network from the available networks ([Figure 12-2](#)).

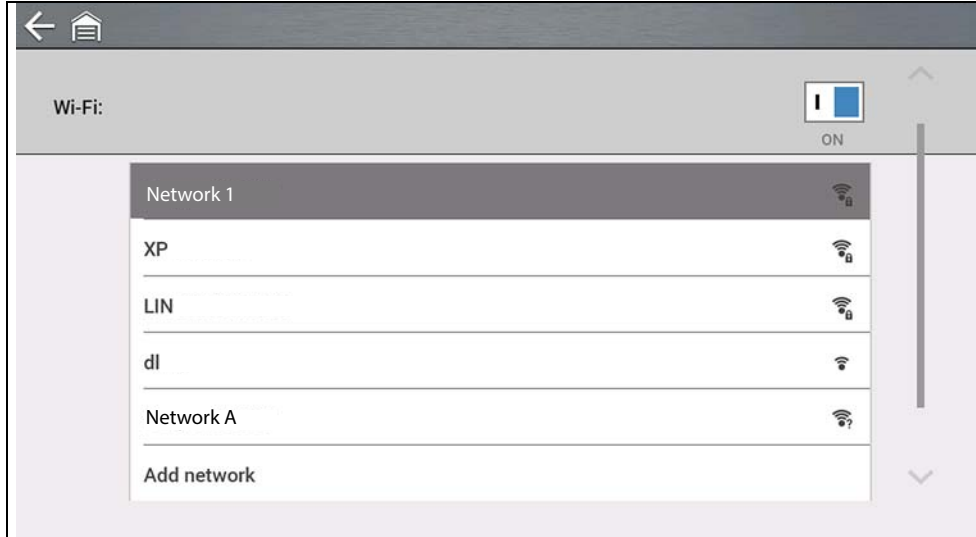

Figure 12-2

## NOTES

*A password is required when choosing a secured (protected) network.*

*Networks with a proxy, challenge page, or that require the user to accept terms of usage are not supported.*

*Wi-Fi performance varies depending on your wireless network equipment and ISP.*

- Enter the required password and press **Next**, or select **Connect** to continue.
- Select **OK** to connect, or **Forget** to cancel.
  - The Snap-on Cloud registration information is displayed. For Snap-on Cloud registration information see [Snap-on Cloud](#) on page 12.
  - If “Not Connected” is displayed, try to reconnect or see [“Wi-Fi Testing”](#) on page 79 for additional information.

## 12.3 Add Network Advanced (Connecting to a hidden network)

The Add Network selection allows you to connect to a network that is not broadcasting its name (not visible in the displayed network list). These networks are also known as “hidden” networks.

To connect to a hidden network you will first need to know the following:

- Network Security Type
  - Open (only need SSID)
  - WPA or WPA2 (Pre-shared key)
  - Note - WEP encryption is NOT supported**
- Network name or SSID (Service Set Identifier)
- Network Password

### Navigation

Home Screen: [Tools](#) > [Settings](#) > [Configure Wi-Fi](#)

- To connect, select **Add Network Advanced** from the available network list.
- Select security type Open, WPA, or WPA2. Refer to the router user manual or your IT administrator to determine the type.
- Enter the network name or SSID
- Enter the network password and press **Next**.
- Select **OK** to connect.

## 12.4 Wi-Fi Testing

If you are experiencing network connection issues, an automated testing feature is available to quickly test your network connection.

1. Turn off the diagnostic tool and then turn it on. This clears previous testing messages from memory.
2. Connect to your desired network, see [“Turning Wi-Fi On and Connecting to a Network” on page 77](#).
3. From the Wi-Fi configuration screen, select the **Wi-Fi Test** icon .

Three pass/fail connection test are performed. If a connection issue(s) is present, select **View Summary** ([Figure 12-3](#)) to review the results for details.

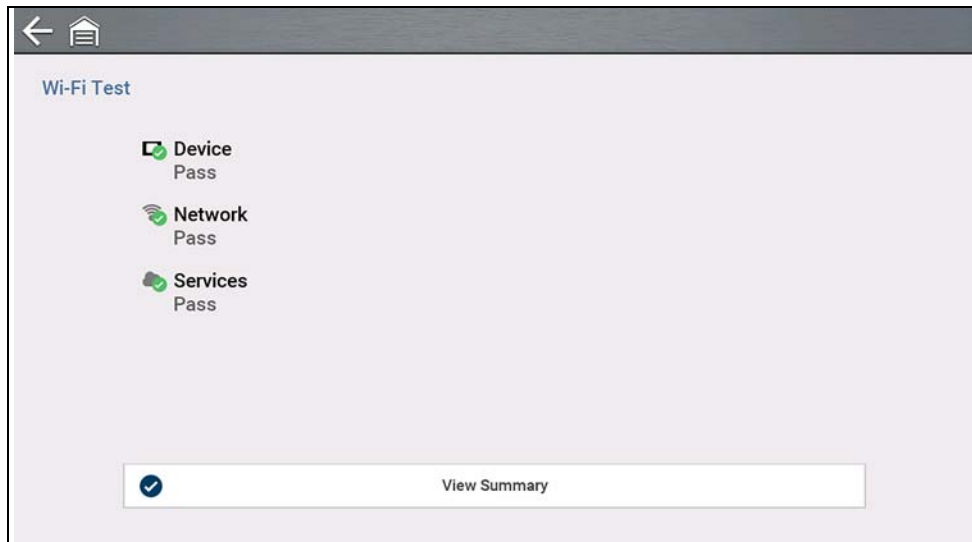

Figure 12-3

## 12.5 Wi-Fi Troubleshooting and Status Messages

The following troubleshooting information is not inclusive and is meant as a guide only. Other issues and solutions may arise that are not stated here. The following description of terms are provided for reference as used in the following troubleshooting chart:

- **Router** - The data transmission device directly connected to your ISP.
- **Remote Wireless Access Point** - A wireless connection device between the router and your diagnostic tool.
- **Wi-Fi Radio** - The internal diagnostic tool radio transmitting and receiving Wi-Fi signals.
- **Network Connection** - Also called Wi-Fi connection. The configured Wi-Fi router connection the diagnostic tool connects to. This connection can be secured (password protected) or unsecured (open).

### Router Information

Router compatibility and setup are important factors to check when trying to determine connectivity problems. Although we have tested this device at the factory to verify connectivity, we cannot guaranty its connectivity with your specific equipment. There may be some situations that require your time for router connection troubleshooting and/or additional consultation and equipment. Snap-on Incorporated is not responsible for any costs incurred for any additional equipment, labor or consultation charges or any other costs that may result from correcting non-connectivity issues with this device.

### IMPORTANT

***Routers using WEP encryption are not supported and should not be used.***



### Check Router Settings

Verify the following router settings **BEFORE** you begin troubleshooting a non-connectivity or “No Connection” problem. After each check, make any corrections as necessary then retest for connectivity. **Contact your IT administrator or ISP for assistance.**

1. Check your router connection and if applicable, the remote wireless access point connection.
2. Clear saved Wi-Fi networks, see [Clearing Wi-Fi Networks on page 80](#) below.
3. Verify:
  - (a). Router is configured to use Dynamic Host Configuration Protocol (DHCP), not a static IP address.
  - (b). Router and/or settings for this device are configured to 2.4GHz. 5GHz is supported, however 2.4GHz is the preferred setting as it provides more range.
  - (c). Router is configured to B/G and/or N standard wireless networks to 2.4GHz. 5GHz is supported, however 2.4GHz is the preferred setting, as it provides more range.  
See your router "User Guide" for setup, connection and troubleshooting procedures.

### IMPORTANT

**Routers using WEP encryption are not supported and should not be used.**

4. Check for router firmware and update to current version, if applicable.
5. Restart or reset the router. See your router "User Guide" for procedures.
6. Connect to a different router.

### Clearing Wi-Fi Networks

1. Select the Wi-Fi network that you are trying to connect to from the list of saved networks on the Wi-Fi configuration menu.  
The Wi-Fi Summary page displays.
2. Select **FORGET**  
The Wi-Fi Configuration menu displays.
3. Repeat steps (1) and (2) for ALL saved Wi-Fi networks.
4. Once all saved Wi-Fi networks have been deleted (forgotten) turn off the diagnostic tool.
5. Turn on the diagnostic tool and connect to the desired Wi-Fi network, see [Turning Wi-Fi On and Connecting to a Network on page 77](#).

### General -Troubleshooting

Problem	Possible Cause	Corrective Action
Information Services are not available	Access has expired	Contact your sales representative.
	Access may be temporarily unavailable	Try to access the function at a later time as updates may be in process.
	Wi-Fi radio is turned Off	1. From the Home screen, navigate to <b>Tools &gt; Settings &gt; Configure Wi-Fi</b> . 2. Select the <b>Wi-Fi</b> icon and turn the Wi-Fi radio on. The Wi-Fi icon will change from a green check mark icon to red "X" mark icon indicating Wi-Fi radio is on. 3. Connect to a known good network.
Wi-Fi connection drops off or disconnects intermittently	Not connecting to a network	1. Clear saved Wi-Fi networks, see <a href="#">Clearing Wi-Fi Networks on page 80</a> . 2. Connect to a network. 3. From the Configure Wi-Fi screen select the <b>Wi-Fi Test</b> icon and review the results. See <b>Connection Tests - Troubleshooting</b> in the following table.
	Wi-Fi Signal strength insufficient	Check Wi-Fi signal strength - out of range or interference. Move closer (within 50 Ft. (15 M) or into a direct open sight-line of the router or if applicable, remote wireless access point. Eliminate interference from overhead lights, windows, walls, other wireless devices, metal objects and devices that emit electrostatic discharge. Configure router to 2.4GHz for extended range capability.
Wi-Fi connection drops off or disconnects intermittently	Router overloaded	Disconnect/disable other Wi-Fi devices connected to the router.



Connection Tests - Troubleshooting		
Failed Test	Possible Cause (Displayed Tip Message*)	Corrective Action / Checks
Device	Wi-Fi radio not responding and/or will not turn off	Contact Customer Support for assistance.
	Wi-Fi radio not responding and/or will not initialize	
	Missing or corrupt firmware file(s)	
Network	This device is not connected to a router	Check Wi-Fi signal strength - out of range or interference. Move closer (within 50 Ft. (15 M) or into a direct open sight-line of the router or if applicable, remote wireless access point. Eliminate interference from overhead lights, windows, walls, other wireless devices, metal objects and devices that emit electrostatic discharge. Configure router to 2.4GHz for extended range capability.
		Check router connection and setup. See <a href="#">Check Router Settings on page 80</a> for procedure.
	This device is not connected to the Internet or has no DNS	Check router connection and setup. See <a href="#">Check Router Settings on page 80</a> for procedure.
Domain Name System (DNS) server not connected. Contact your Internet service provider (ISP).		
This device cannot communicate using HTTP	Check if your Internet access uses a "Proxy" or "Accepting terms in a browser" protocol, or uses a challenge page. These protocols are not supported by this device. Contact your IT administrator or ISP for options.	
Information Services are not available	Your access has expired	Contact your sales representative.
	Information Services may be temporarily unavailable or Not connecting to a network	Try to access at a later time as Information Services may be performing updates to the service. Check router connection and setup. See <a href="#">Check Router Settings on page 80</a> for procedure.



# Legal Information

## Trademarks

Snap-on and SureTrack are trademarks registered in the United States and other countries of Snap-on Incorporated. All other marks are trademarks or registered trademarks of their respective holders.

## Copyright Information

© 2020 Snap-on Incorporated. All rights reserved.

## Software License Information

Use of Software is governed by the terms and conditions of the End User License Agreement. The diagnostic tool should not be initially operated until the End User License Agreement is read. Use of the device acknowledges your acceptance of the End User License Agreement. The Snap-on Incorporated Software End User License Agreement may be provided with the diagnostic tool, and is available at: <https://eula.snapon.com/diagnostics>

## Patent Information

For a listing of Snap-on products that are protected by patents in the United States and elsewhere, visit: <https://patents.snapon.com>

## Disclaimer of Warranties and Limitation of Liabilities

All pictures and illustrations shown are for reference purposes only. All information, specifications and illustrations in this manual are based on the latest information available at the time of printing and are subject to change without notice. While the authors have taken due care in the preparation of this manual, nothing contained herein:

- Modifies or alters in any way the standard terms and conditions of the purchase, lease, or rental agreement under the terms of which the equipment to which this manual relates was acquired.
- Increases in any way the liability to the customer or to third parties.

Snap-on® reserves the right to make changes at any time without notice.

### IMPORTANT

***Before operating or maintaining this unit, please read this manual carefully paying extra attention to the safety warnings and precautions.***





## FCC Compliance Statement

This equipment has been tested and found to comply with the limits for a Class B digital device, pursuant to part 15 of the FCC rules. These limits are designed to provide reasonable protection against harmful interference in a residential installation. This equipment generates, uses and can radiate radio frequency energy and, if not installed and used in accordance with the instructions, may cause harmful interference to radio communications. However, there is no guarantee that interference will not occur in a particular installation. If this equipment does cause harmful interference to radio or television reception, which can be determined by turning the equipment off and on, the user is encouraged to try to correct the interference by one or more of the following measures:

- Reorient or relocate the receiving antenna.
- Increase the separation between the equipment and receiver.
- Connect the equipment into an outlet on a circuit different from that to which the receiver is connected.
- Consult the dealer or an experienced radio/TV technician for help.

### CAUTION

You are cautioned that changes or modifications not expressly approved by the party responsible for compliance could void your authority to operate the equipment.

### FCC RF Radiation Exposure Statement

1. This transmitter must not be co-located or operating in conjunction with any other antenna or transmitter.
2. This equipment complies with FCC RF radiation exposure limits set forth for an uncontrolled environment. This device was tested for typical lap held operations with the device contacted directly to the human body to the back side of the Display Unit. To maintain compliance with FCC RF exposure compliance requirements, avoid direct contact to the transmitting antenna during transmitting.
3. According to FCC 15.407(e), the device is intended to operate in the frequency band of 5.15GHz to 5.25GHz under all conditions of normal operation. Normal operation of this device is restricted to indoor use only to reduce any potential for harmful interference to co-channel MSS operations.