

# Diagnostic Thermal Imager ELITE



## User Manual



---

# Legal Information

## Trademarks

Snap-on is a trademark registered in the United States and other countries of Snap-on Incorporated. All other marks are trademarks or registered trademarks of their respective holders.

## Copyright Information

© 2018 Snap-on Incorporated. All rights reserved.

## Software License Information

Use of Software is governed by the terms and conditions of the End User License Agreement. The diagnostic tool should not be initially operated until the End User License Agreement is read. Use of the device acknowledges your acceptance of the End User License Agreement. The Snap-on Incorporated Software End User License Agreement may be provided with the diagnostic tool, and is available at: <https://eula.snapon.com/diagnostics>

## Third Party Acknowledgments

This device contains third-party software licensed by ARM Limited

Copyright © 2009-2013 ARM Limited

Copyright © 2013-2015 ARM Limited

Copyright © 2013-2016 ARM Limited

This device contains third-party software licensed by Keil - an ARM Company

Copyright © 2004-2014 Keil - An ARM Company

This device contains third-party software licensed by FLIR Systems - Commercial Vision Systems

Copyright © 2011, 2012, 2013, 2014 FLIR Systems

THIS SOFTWARE IS PROVIDED BY THE COPYRIGHT HOLDERS AND CONTRIBUTORS "AS IS" AND ANY EXPRESS OR IMPLIED WARRANTIES, INCLUDING, BUT NOT LIMITED TO, THE IMPLIED WARRANTIES OF MERCHANTABILITY AND FITNESS FOR A PARTICULAR PURPOSE ARE DISCLAIMED. IN NO EVENT SHALL COPYRIGHT HOLDERS AND CONTRIBUTORS BE LIABLE FOR ANY DIRECT, INDIRECT, INCIDENTAL, SPECIAL, EXEMPLARY, OR CONSEQUENTIAL DAMAGES (INCLUDING, BUT NOT LIMITED TO, PROCUREMENT OF SUBSTITUTE GOODS OR SERVICES; LOSS OF USE, DATA, OR PROFITS; OR BUSINESS INTERRUPTION) HOWEVER CAUSED AND ON ANY THEORY OF LIABILITY, WHETHER IN CONTRACT, STRICT LIABILITY, OR TORT (INCLUDING NEGLIGENCE OR OTHERWISE) ARISING IN ANY WAY OUT OF THE USE OF THIS SOFTWARE, EVEN IF ADVISED OF THE POSSIBILITY OF SUCH DAMAGE

## Patent Information

For a listing of Snap-on products that are protected by patents in the United States and elsewhere, visit: <https://patents.snapon.com>

## Disclaimer of Warranties and Limitation of Liabilities

All pictures and illustrations shown are for reference purposes only. All information, specifications and illustrations in this manual are based on the latest information available at the time of printing and are subject to change without notice. While the authors have taken due care in the preparation of this manual, nothing contained herein:

- Modifies or alters in any way the standard terms and conditions of the purchase, lease, or rental agreement under the terms of which the equipment to which this manual relates was acquired.
- Increases in any way the liability to the customer or to third parties.

Snap-on® reserves the right to make changes at any time without notice.

---

### **IMPORTANT:**

Before operating or maintaining this unit, please read this manual carefully paying extra attention to the safety warnings and precautions.





---

The information in this manual is periodically revised to ensure the latest information is included. Download the latest version of this manual and other related product support documentation from the Snap-on Diagnostics website.

---

## Product Compliance and Certification

This product is certified and/or in compliance with the guidelines and regulations set forth by the following:

| United States and Canada  |   | Europe  | Australia   |
|---|---|---|---|
| (California Only)<br>California Energy<br>Commission (CEC)                        | (U.S. and Canada)<br>Underwriters Laboratories (UL)                               | Conformité Européene<br>(European Conformity)                                     | Regulatory Compliance Mark (RCM)  |
|  |  |  |  |

### FCC Compliance Statement

**FCC ID: XF6-RS9113SB**

This equipment has been tested and found to comply with the limits for a Class B digital device, pursuant to part 15 of the FCC rules. These limits are designed to provide reasonable protection against harmful interference in a residential installation. This equipment generates, uses and can radiate radio frequency energy and, if not installed and used in accordance with the instructions, may cause harmful interference to radio communications. However, there is no guarantee that interference will not occur in a particular installation. If this equipment does cause harmful interference to radio or television reception, which can be determined by turning the equipment off and on, the user is encouraged to try to correct the interference by one or more of the following measures:

- Reorient or relocate the receiving antenna.
- Increase the separation between the equipment and receiver.
- Connect the equipment into an outlet on a circuit different from that to which the receiver is connected.
- Consult the dealer or an experienced radio/TV technician for help.

### CAUTION

You are cautioned that changes or modifications not expressly approved by the party responsible for compliance could void your authority to operate the equipment.

### FCC RF Radiation Exposure Statement

1. This transmitter must not be co-located or operating in conjunction with any other antenna or transmitter.
2. This equipment complies with FCC RF radiation exposure limits set forth for an uncontrolled environment. This device was tested for typical lap held operations with the device contacted directly to the human body to the back side of the Display Unit. To maintain compliance with FCC RF exposure compliance requirements, avoid direct contact to the transmitting antenna during transmitting.
3. According to FCC 15.407(e), the device is intended to operate in the frequency band of 5.15GHz to 5.25GHz under all conditions of normal operation. Normal operation of this device is restricted to indoor use only to reduce any potential for harmful interference to co-channel MSS operations.

## Customer Support Information

| North America       |   |
|---------------------|---|
| Website             | <a href="http://diagnostics.snapon.com">http://diagnostics.snapon.com</a>                                   |
| Phone               | 1-800-424-7226  |
| E-mail              | diagnostics_support@snapon.com  |
| Online Contact Form | <a href="https://www1.snapon.com/diagnostics/us/Contact">https://www1.snapon.com/diagnostics/us/Contact</a> |

| United Kingdom |   |
|----------------|---|
| Website        | <a href="http://diagnostics.snapon.co.uk">http://diagnostics.snapon.co.uk</a> |
| Phone          | +44 (0) 845 601 4736  |
| E-mail         | diagnosticsUKproductsupport@snapon.com  |

| Australia and New Zealand |   |
|---------------------------|---|
| Website                   | <a href="http://www.snapontools.com.au">http://www.snapontools.com.au</a> |
| Phone                     | (Australia) 1800-810-581  |
|                           | (New Zealand) 0800-762-766  |
| E-mail                    | sota.diagnostics@snapon.com   |

| The Netherlands and Belgium |   |
|-----------------------------|---|
| Website                     | <a href="http://www.eurotechcenter.nl">http://www.eurotechcenter.nl</a> |
| Phone                       | NL +31 (0) 356-242322   |
|                             | BE +32 (0) 380 80537  |
| E-mail                      | helpdesk@eurotechcenter.nl  |

| Deutschland |   |
|-------------|---|
| Website     | <a href="http://www.snapon.de/startseite.html">http://www.snapon.de/startseite.html</a> |
| Phone       | +49 (0) 3723-66820-12   |
| E-mail      | decustomerservices@snapon.com   |

For technical assistance in all other markets, contact your selling agent.

# Contents

|  |             |
|--|-------------|
| <b>Safety Information</b> .....                  | <b>viii</b> |
| <b>Chapter 1: Using This Manual</b> .....        | <b>1</b>    |
| Conventions .....                                | 1           |
| Bold Text .....                                  | 1           |
| Symbols .....                                    | 1           |
| Terminology .....                                | 1           |
| Notes and Important Messages .....               | 2           |
| Hyperlinks .....                                 | 2           |
| <b>Chapter 2: Technical Specifications</b> ..... | <b>3</b>    |
| <b>Chapter 3: Features and Controls</b> .....    | <b>5</b>    |
| General Features .....                           | 5           |
| Controls and Connections .....                   | 6           |
| Default Screen Features .....                    | 7           |
| <b>Chapter 4: Operation</b> .....                | <b>8</b>    |
| Main Topic Links .....                           | 8           |
| Startup / Shutdown (On/Off) .....                | 8           |
| Connecting to Wi-Fi (ALTUSDRIVE.com) .....       | 9           |
| Basic Operation (Live Mode) .....                | 9           |
| Special Button Functions (Live Mode) .....       | 9           |
| Changing View Settings (Live Mode) .....         | 10          |
| About Temperature Readings .....                 | 11          |
| Using Full Thermal Mode .....                    | 12          |
| Using Overlay Opacity Mode .....                 | 12          |
| Using Visual Light (Camera) Mode .....           | 14          |
| Using the Menu (Menu Mode) .....                 | 15          |
| Using the LED Spotlight .....                    | 17          |
| <b>Chapter 5: Settings</b> .....                 | <b>18</b>   |
| Main Topic Links .....                           | 18          |
| Settings Menu .....                              | 19          |
| Wi-Fi Connection .....                           | 20          |
| ALTUS Setup .....                                | 23          |
| Date and Time .....                              | 24          |
| Color Palette .....                              | 24          |
| Brightness .....                                 | 25          |
| Language .....                                   | 25          |
| Automatic Shutdown .....                         | 26          |
| Navigation Tips .....                            | 26          |
| Spotlight Intensity .....                        | 27          |
| Thermal Camera Calibration .....                 | 28          |
| Advanced .....                                   | 28          |

|   |           |
|---|-----------|
| <b>Chapter 6: Images and Video .....</b>                              | <b>32</b> |
| Main Topic Links.....   | 32        |
| Capturing and Saving Images .....                                     | 32        |
| About Image File Names .....  | 32        |
| Recording and Saving Video .....                                      | 33        |
| Using the Gallery (Viewing / Deleting).....                           | 33        |
| Opening the Gallery and Selecting a File.....                         | 33        |
| Viewing Images in the Gallery.....                                    | 35        |
| Deleting Images from the Gallery.....                                 | 35        |
| Transferring Files to a PC.....                                       | 36        |
| <br>  |           |
| <b>Chapter 7: Expert Tips / Demo .....</b>                            | <b>37</b> |
| Expert Tips .....   | 37        |
| Demonstration Mode .....  | 40        |
| <br>  |           |
| <b>Chapter 8: ALTUS (ALTUSDRIVE.com) - Image Sharing/Storage.....</b> | <b>41</b> |
| Main Topic Links.....   | 41        |
| Key Features .....  | 41        |
| Important Notes .....   | 41        |
| Registration - Getting Started .....                                  | 42        |
| ALTUS - New User Registration .....                                   | 42        |
| ALTUS - SureTrack User Setup.....                                     | 43        |
| Using ALTUS.....  | 44        |
| Navigating ALTUS (Toolbars).....                                      | 45        |
| Quick Reference (ALTUS Operation) .....                               | 45        |
| My Files.....   | 46        |
| Search.....   | 51        |
| Favorites .....   | 52        |
| Profile.....  | 53        |
| <br>  |           |
| <b>Chapter 9: Application Examples .....</b>                          | <b>58</b> |
| Examples.....   | 59        |
| <br>  |           |
| <b>Chapter 10: Maintenance .....</b>                                  | <b>62</b> |
| Main Topic Links.....   | 62        |
| Storage .....   | 62        |
| Cleaning .....  | 62        |
| Battery Pack .....  | 63        |
| Safety Guidelines.....  | 63        |
| Battery Information.....  | 64        |
| Battery Charging .....  | 64        |
| Removal / Installation.....   | 66        |
| Ordering a Replacement Battery .....                                  | 68        |
| Disposal .....  | 69        |
| <br>  |           |
| <b>Chapter 11: Troubleshooting .....</b>                              | <b>70</b> |
| General Troubleshooting Chart .....                                   | 70        |
| Wi-Fi Troubleshooting .....   | 71        |
| Wi-Fi - Icon Identification.....                                      | 71        |
| Wi-Fi Connection Status .....   | 72        |
| Router Information .....  | 73        |

## Contents

---

|                                     |    |
|-------------------------------------|----|
| Check Router Settings .....         | 73 |
| Clearing Wi-Fi Networks .....       | 73 |
| General Wi-Fi Troubleshooting ..... | 74 |



---

# Safety Information

## READ ALL INSTRUCTIONS

For your own safety, the safety of others, and to prevent damage to the product and vehicles upon which it is used, it is important that all instructions and safety messages in this manual and in the *Important Safety Instructions* (included with the Thermal Imager) be read and understood by all persons operating, or coming into contact with the product, before operating. We suggest you store a copy of each, near the product in sight of the operator.

For your safety, read all instructions. Use your diagnostic tools only as described in the tool user's manual. Use only manufacturer recommended parts and accessories with your diagnostic tools.

This product is intended for use by properly trained and skilled professional automotive technicians. The safety messages presented throughout this manual and in the supplied *Important Safety Instructions* are reminders to the operator to exercise extreme care when using this product.

There are many variations in procedures, techniques, tools, and parts for servicing vehicles, as well as in the skill of the individual doing the work. Because of the vast number of test applications and variations in the products that can be tested with this instrument, we cannot possibly anticipate or provide advice or safety messages to cover every situation. It is the responsibility of the automotive technician to be knowledgeable of the system being tested. It is essential to use proper service methods and test procedures. It is important to perform tests in an appropriate and acceptable manner that does not endanger your safety, the safety of others in the work area, the equipment being used, or the vehicle being tested.

It is assumed that the operator has a thorough understanding of vehicle systems before using this product. Understanding of these system principles and operating theories is necessary for competent, safe and accurate use of this instrument.

Before using the equipment, always refer to and follow the safety messages and applicable test procedures provided by the manufacturer of the vehicle or equipment being tested. Use the product only as described in its user manual. Use only manufacturer recommended parts and accessories with your product.

Read, understand and follow all safety messages and instructions in this manual, the supplied *Important Safety Instructions*, and on the test equipment.

### **Environmental Conditions:**

- This product is intended for indoor use only
- This product is rated for Pollution Degree 2 (normal conditions)

## Safety Signal Words

All safety messages contain a safety signal word that indicates the level of the hazard. An icon, when present, gives a graphical description of the hazard. Safety Signal words are:

### **DANGER**

Indicates an imminently hazardous situation which, if not avoided, will result in death or serious injury to the operator or to bystanders.

### **WARNING**

Indicates a potentially hazardous situation which, if not avoided, could result in death or serious injury to the operator or to bystanders.

### **CAUTION**

Indicates a potentially hazardous situation which, if not avoided, may result in moderate or minor injury to the operator or to bystanders.

## Safety Message Conventions

Safety messages are provided to help prevent personal injury and equipment damage. Safety messages communicate the hazard, hazard avoidance and possible consequences using three different type styles:

- Normal type states the hazard.
- **Bold type states how to avoid the hazard.**
- *Italic type states the possible consequences of not avoiding the hazard.*

An icon, when present, gives a graphical description of the potential hazard.

## Safety Message Example

### **WARNING**



Risk of unexpected vehicle movement.

- **Block drive wheels before performing a test with engine running.**

*A moving vehicle can cause injury.*

## Important Safety Instructions

For a complete list of safety messages, refer to the accompanying *Important Safety Instructions manual*.

**SAVE THESE INSTRUCTIONS**

This manual contains basic operating instructions and is structured in a manner to help you become familiar with the tool features and perform basic operations.

The illustrations in this manual are intended as reference only and may not depict actual screen results, information, functions or standard equipment.

The following information is intended as reference, using general content to describe the use of conventions in this manual. Not all examples, conventions or content may be used, or applicable within this manual.

## 1.1 Conventions

### 1.1.1 Bold Text

Bold emphasis is used in procedures to highlight selectable items such as buttons and menu options.

Example:

- Select **Functions**.

### 1.1.2 Symbols

The “greater than” arrow (>) indicates an abbreviated set of selection instructions.

Example:

- Select **Utilities > Tool Setup > Date**.

The above statement abbreviates the following procedure:

1. Select the **Utilities** icon.
2. Select the **Tool Setup** submenu.
3. Highlight the **Date** option from the submenu.

### 1.1.3 Terminology

The term “select” describes tapping/touching an icon on the touch screen, or highlighting an icon or menu choice and then selecting the confirmation menu choice such as **Continue, Accept, OK, Yes**, or other similar choice.

Example:

- Select **Reset**.

The above statement abbreviates the following procedure:

1. Navigate to the **Reset** icon.
2. Select the **Reset** icon with your stylus.

## 1.1.4 Notes and Important Messages

The following messages are used.

### Note

A note provides helpful information such as additional explanations, tips, and comments.

Example:

**NOTE:**

For additional information refer to...

---

### Important

Important indicates a situation which, if not avoided, may result in damage to the test equipment or vehicle.

Example:

---

**IMPORTANT:**

Do not use any abrasive cleansers or automotive chemicals on the tool.

---

## 1.1.5 Hyperlinks

Hyperlinks, or links, that take you to other related articles, procedures, and illustrations are available in electronic documents. Blue colored text indicates a selectable hyperlink.

Example:

---

**IMPORTANT:**

Read all applicable [Safety Information](#) before using this tool!

---

| Item   | Description / Specification   |
|--|---|
| <b>Display (LCD)</b>                         | Size (diagonal): 109mm (4.3 in.)  |
|  | Resolution: 480 x 272 pixels  |
| <b>Digital Camera</b>                        | Focus: Fixed  |
| <b>Thermal Imager</b>                        | Temperature Measurement Range: -20 to 450 °C (-4 to 840 °F)   |
|  | Color Palettes: 4 options: Iron, Rainbow, Grey-Iron, Cool-Hot   |
|  | Thermal Sensitivity (NETD): < 50mK (millidegrees Kelvin)  |
|  | IR Image Refresh Rate: < 9 times per second   |
|  | Radiometric Accuracy:<br>Typical (at 68°F (20°C)): ±5°C or ±5% (whichever is greater)<br>Maximum (over total temperature range): ±7°C or ±5% (whichever is greater) |
|  | Spectral Range: Longwave infrared, 8 to 14 μm   |
|  | IR Image Detector Type: Uncooled LWIR (Long Wave Infrared)  |
|  | Effective Distance: Optimum results when used within 5 ft. (1.5 m)  |
|  | Spot Size Ratio: 14:1   |
| <b>LED Spotlight</b>                         | Low: 7 lumens   |
|  | Med.: 12 lumens   |
|  | High: 22 lumens   |
| <b>Image Storage Memory Capacity</b>         | > 15000 images or 225 video recordings (total depends on the number and size of the files)  |
| <b>Image File Format</b>                     | .bmp  |
| <b>Video File Format</b>                     | .avi  |
| <b>USB Interface</b>                         | 2.0 USB, micro USB  |
| <b>Battery</b>                               | Rechargeable Lithium Ion Battery Pack (+3.7V, 2800mAh (nominal))  |
|  | Approximate 4 hour continuous operation, with the brightness level setting at 50%   |
|  | Approximate 80% charge in 3-hours, 100% charge in less than 5-hours   |
| <b>USB Power Supply Rating</b>               | 5 VDC, 2A   |
| <b>Operating Voltage (USB input)</b>         | 4.75 to 5.25 VDC  |
| <b>Operating Altitude</b>                    | Maximum 2000 m  |
| <b>Width</b>                                 | 4.80 in. (122.0 mm)   |
| <b>Height</b>                                | 9.09 in. (231.0 mm)   |
| <b>Depth</b>                                 | 2.24 in. (57.0 mm)  |
| <b>Weight</b>                                | 0.83 lb (376.5 g)   |
| <b>Operating Temperature Range (ambient)</b> | At 0 to 90% relative humidity (non-condensing)<br>32 to 113°F (0 to 45°C)   |
| <b>Storage Temperature (ambient)</b>         | At 0 to 70% relative humidity (non-condensing)<br>-4 to 140°F (-20 to 60°C)   |
| <b>Environmental Conditions</b>              | This product is intended for indoor use only. It is not rated for damp or wet locations.  |
|  | This product is rated for Pollution Degree 2 (normal conditions)  |

## Technical Specifications

---

| Item                  | Description / Specification                             |
|-----------------------|---|
| <b>Wi-Fi Features</b> | FCC,IC,ETSI/CE,TELEC Certified                          |
|                       | IEEE 802.11 Compliant, b/g/n with single band (2.4 GHz) |
|                       | WLAN Transmit Power: 17 dBm                             |
|                       | WLAN Receive Sensitivity: -97 dBm @ 1Mbps               |
|                       | WPA/WPA2 Personal, WEP                                  |

This chapter introduces the basic features of the Diagnostic Thermal Imager Elite.

The thermal imager is a specialized device used to make non-contact thermal measurements, and visually reveal heat sources to help locate and identify vehicle faults (e.g. friction, electrical impedance, engine misfires, fluid blockage, HVAC leaks and more).

The thermal imager also has the capability to capture still images and video in all display modes (e.g. visual light, overlay and full thermal).

In addition, the thermal imager includes a built-in feature that automatically transfers captured images to your ALTUS™ account. ALTUS (ALTUSDRIVE.com) is a mobile-friendly cloud-based site designed specifically for technicians to store, organize and share information, see [ALTUS \(ALTUSDRIVE.com\) - Image Sharing/Storage](https://ALTUSDRIVE.com) on page 41.

### 3.1 General Features





- |  |                           |
|--|---------------------------|
| 1. Power (On/Off) Button                         | 8. Protective Cover (USB) |
| 2. Cancel (N) Button (dual function)             | 9. Thermal Imager Window  |
| 3. Accept (Y) Button (dual function)             | 10. Visible Light Window  |
| 4. Control Buttons {Directional} (dual function) | 11. LED Spotlight         |
| 5. Menu Button                                   | 12. Trigger               |
| 6. Battery Charge Indicator                      | 13. Battery Pack Cover    |
| 7. Display                                       |                           |



Figure 3-1

## 3.2 Controls and Connections



| Item | Name   | Description/Operation   |
|------|--|---|
| 1    | <b>Battery Charge Indicator</b>              | The battery charge LED indicator illuminates red when the battery is being charged. The LED will turn green when battery is fully charged.  |
| 2    | <b>microSD (Secure Digital) Card</b>         | The microSD card stores saved images, videos, and expert tips content. During operation the microSD card must be installed to save and view images/videos, and view expert tips.  |
| 3    | <b>micro USB Jack</b>                        | The micro USB jack provides connection (via supplied USB cable) for the power supply adapter (battery charging), and to a personal computer for saved image transfer.   |
|      | <b>Protective Cover (Item 8 in Fig. 2-1)</b> | <i>A protective cover is used over the USB jack and microSD card slot, located on top of the Imager. Always keep the protective cover closed during operation. Only open the protective cover during battery charging, or when connecting to the PC, or removing the microSD card. Opening the protective cover during operation could result in an electrostatic discharge event that may cause the Thermal Imager to reset. If this occurs, the Thermal Imager will reset and return to normal operation without being damaged.</i> |
| 4    | <b>Trigger</b>                               | Pull to capture an image of the active display, or start/stop video recording.  |
| 5    | <b>Video Capture and Cancel (No) Button</b>  |  <p><b>Dual Function</b><br/> <b>Live Mode</b> - press to start/stop video recording mode. See <a href="#">Special Button Functions (Live Mode)</a> on page 9.<br/> <b>Menu Mode</b> - use to close a menu, and or return to the previous menu or screen.</p>  |
| 6    | <b>LED Spotlight and Accept (Yes) Button</b> |  <p><b>Dual Function</b><br/> <b>Live Mode</b> - press to turn the LED spotlight on/off. See <a href="#">Special Button Functions (Live Mode)</a> on page 9.<br/> <b>Menu Mode</b> - press to confirm, or select a menu option.</p>  |
| 7    | <b>Menu Button</b>                           |  <p>Press to open the main menu.</p>   |



| Item | Name                                       | Description/Operation   |  |
|------|--|---|--|
| 8    | Up / Down Control Buttons {Directional}    |  | <b>Dual Function</b><br><b>Live Mode</b> - press to change the overlay opacity setting. See <a href="#">Special Button Functions (Live Mode)</a> on page 9.<br><b>Menu Mode</b> - press to navigate up / down in menu options.             |
| 9    | Left / Right Control Buttons {Directional} |  | <b>Dual Function</b><br><b>Live Mode</b> - press to change the view setting. See <a href="#">Special Button Functions (Live Mode)</a> on page 9.<br><b>Menu Mode</b> - press to navigate left / right on the toolbar, and in menu options. |
| 10   | Power Button                               |  | Press to turn the thermal imager on/off.   |

### 3.3 Default Screen Features

The default screen is a Live Mode screen and is displayed upon initial start up. See [Basic Operation \(Live Mode\)](#) on page 9 for additional information.



**NOTE:**

Opacity and view settings are saved when the thermal imager is turned off, allowing you to resume operation with the same settings last used.

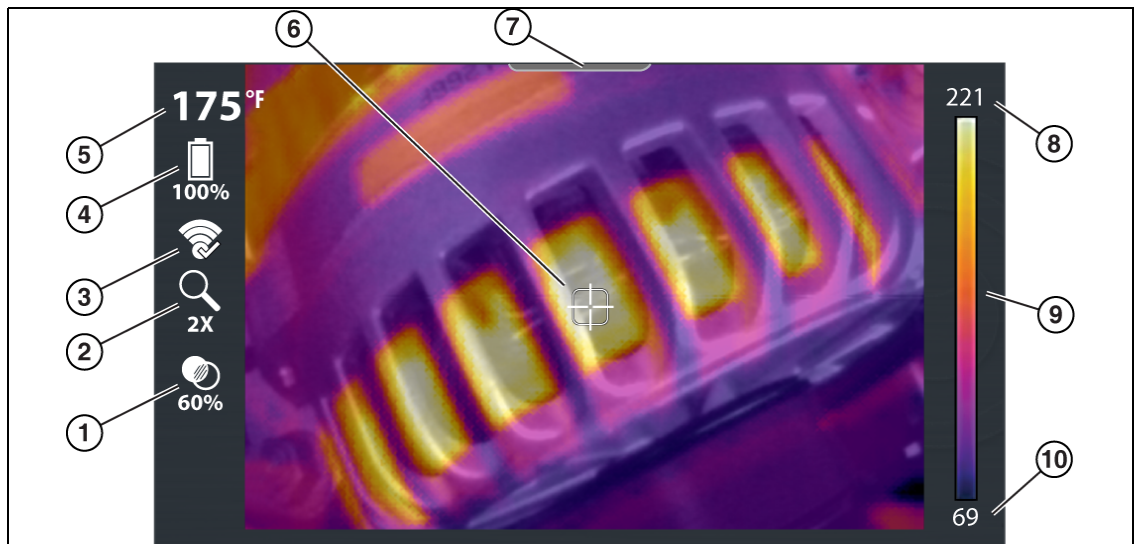

1. Opacity Percentage Icon, see [Using Overlay Opacity Mode](#) on page 12
2. Zoom Level Icon, see [Changing View Settings \(Live Mode\)](#) on page 10
3. Wi-Fi Icon, see [Wi-Fi Status - Icon Identification](#) on page 22
4. Battery Level Icon
5. Center Region Temperature (Average)
6. Target (Center Region Temperature (Average))
7. Menu Indicator Tab
8. Color Palette - Maximum Temperature Value
9. Color Palette Range Indicator
10. Color Palette - Minimum Temperature Value

Figure 3-2 Default Screen Features

## 4.1 Main Topic Links

The following topics are described in this section:

- [Startup / Shutdown \(On/Off\)](#)
- [Connecting to Wi-Fi \(ALTUSDRIVE.com\)](#)
- [Basic Operation \(Live Mode\)](#)
- [Special Button Functions \(Live Mode\)](#)
- [Using the LED Spotlight](#)
- [Changing View Settings \(Live Mode\)](#)
- [Using Full Thermal Mode](#)
- [Using Overlay Opacity Mode](#)
- [Using Visual Light \(Camera\) Mode](#)
- [Using the Menu \(Menu Mode\)](#)

## 4.2 Startup / Shutdown (On/Off)

If needed, fully charge the battery pack before operation. See [Battery Charging](#) on page 64 for battery pack charging instructions.

- **Startup** - To turn the Thermal Imager **ON**, press and hold the **Power** button until the introductory screen displays, then release. The Thermal Imager is ready for use, however to ensure optimal measurement accuracy, it is recommended to allow the Thermal Imager to “warm-up” a minimum of 5 minutes before operation.

After the Power button is pressed, an audible tone is sounded upon startup.

After the introductory screen fades, the Thermal Imager switches into Live mode. When in Live mode the device is in live capture mode, and allows you to make thermal measurements and capture still images and video in various modes of visible light, and thermal views. See [Basic Operation \(Live Mode\)](#) on page 9.

Onscreen Navigational Tips are provided for select menu navigation procedures. Each tip will appear only once after turning on the Thermal Imager. Navigational Tips can be enabled or disabled, see [Navigation Tips](#) on page 26.

- **Shutdown** - To turn Thermal Imager **OFF**, press and hold the **Power** button for a minimum of 2 seconds until the Thermal Imager turns off.



**NOTE:**

Opacity and view settings are saved when the thermal imager is turned off, allowing you to resume operation with the same setting you last used.

---

- **Emergency Shutdown** - In the event the control buttons have no response, or the unit cannot be turned off using the normal shutdown method, press and hold the **Power** button (approximately 7 seconds) until the Thermal Imager turns off.

### 4.3 Connecting to Wi-Fi (ALTUSDRIVE.com)

The Diagnostic Thermal Imager (DTI) includes a built-in Wi-Fi feature that automatically transfers captured images to ALTUS™, our cloud-based application designed specifically for technicians to store, organize and share thermal image diagnostic information. See [Wi-Fi Connection](#) on page 20 and [ALTUS \(ALTUSDRIVE.com\) - Image Sharing/Storage](#) on page 41 for additional information

### 4.4 Basic Operation (Live Mode)





Upon initial startup (after introductory screen fades) the device switches to **Live Mode** and displays the **Default Screen**, see [Default Screen Features](#) on page 7. Live Mode is the primary operational mode and allows you to take temperature measurements, capture still images, and record video in various view modes (e.g. visible light, overlay and full thermal).

**Mode Description:**

- **Visible Light** - displays objects similar to a standard visible light digital camera, see [Using Visual Light \(Camera\) Mode](#) on page 14.
- **Overlay** - displays objects using visible light with a transparent thermal image overlay, see [Overlay Mode - Operation Options](#) on page 13.
- **Full Thermal** - displays objects as a full thermal image only, see [Using Full Thermal Mode](#) on page 12.



#### 4.4.1 Special Button Functions (Live Mode)

When in Live Mode, view settings can be quickly changed using the control buttons as shortcut buttons. The following table describes the special functions of the control buttons when in live mode.

| Button  | Live Mode Special Button Operations  |
|---|--|
|  | <b>Video Recording - Enable / Disable video recording mode</b> (see <a href="#">Recording and Saving Video</a> on page 33)   |
|  | <b>LED Spotlight - On / Off</b> (see <a href="#">Using the LED Spotlight</a> on page 17).  |
|  | <b>View Setting Options</b> - Use the Left / Right control buttons to toggle through the settings. See <a href="#">Changing View Settings (Live Mode)</a> on page 10.                            |
|  | <b>Overlay Setting Options</b> - (20 to 80% in 20% increments) Use the Up / Down control buttons to toggle through the settings. See <a href="#">Overlay Mode - Operation Options</a> on page 13 |

### 4.4.2 Changing View Settings (Live Mode)

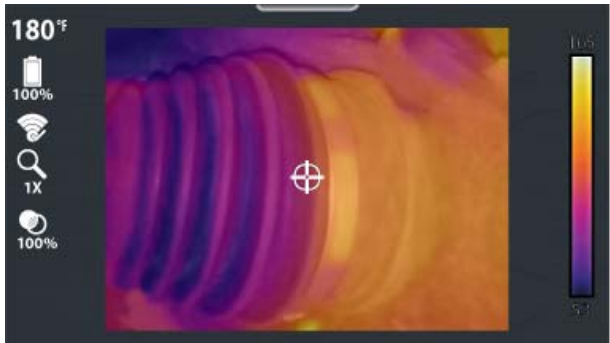
View settings can be changed at any time while in Live mode, using either visual light, thermal or overlay settings. Typical examples of the available view settings are shown below.

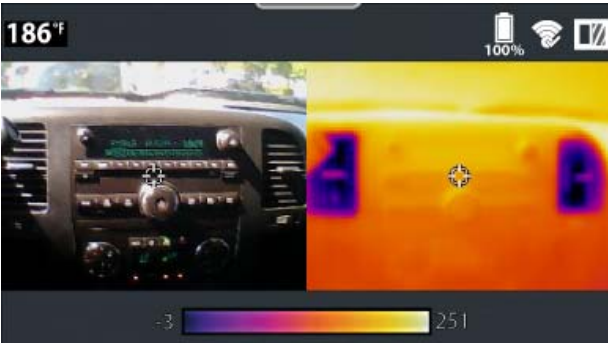
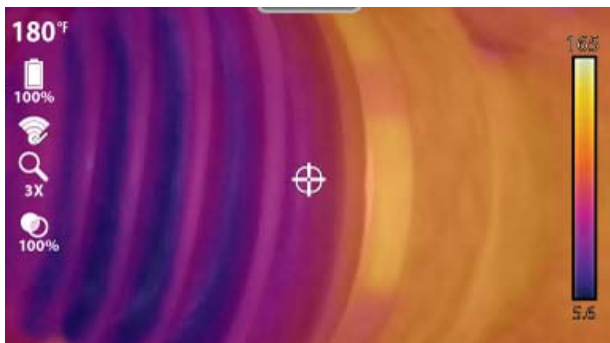
|   |  |   |
|---|--|---|
|    | Use the Left / Right control buttons to toggle through the display settings. |   |
| <h4>1X Zoom</h4>  |  | <h4>Picture in Picture</h4>   |
|    |  |   |
| <h4>2X Zoom</h4>  |  | <h4>Split Screen</h4>   |
|   |  |  |
| <h4>3X Zoom</h4>  |  |   |
|  |  |   |

### 4.4.3 About Temperature Readings

The Thermal Imager measures the emitted infrared radiation from an object(s), and then uses a known emissivity value to effectively calculate the temperature value displayed on the screen.

To accurately calculate temperature from infrared radiation, the emissivity value of the object being measured must be entered, see [Emissivity](#) on page 29.

 **WARNING** - Risk of personal injury or harm.

- Use caution if making physical contact with the surface being measured, as the displayed temperature may be different than the actual temperature.

#### Scale Ranges and Symbols

Depending on the level of emitted infrared radiation being measured, one of two preset temperature scales are automatically used to display the temperature reading onscreen. The temperature scale used is automatically selected based on a percentage of the scene temperature. Temperature scale changes are seamless, and cause no interruption in operation.

Symbols are used to indicate when temperatures are out of the scale range, and are described in the following chart.

| Example   | Description  |
|---|--|
| <p><b>&gt;842°F (&gt;450°C)</b></p> <p>or</p> <p><b>&gt;356°F (&gt;180°C)</b></p> | <p>The "&gt;" symbol is used to indicate when the temperature being measured is above the range of the current scale.</p> <p>The "&gt;" symbol is also used to indicate when the maximum measurable temperature has been reached for the current temperature range. There are two upper limit ranges (see <i>example</i>), and they are automatically selected based on a percentage of the scene temperature.</p> |
| <p><b>&lt;-4°F (&lt;-20°C)</b></p>  | <p>The "&lt;" symbol is used to indicate when the temperature being measured is below -4°F (-20°C).</p>  |

#### Center Region Temperature (Average) and Palette Range Indicator

The target indicator in the center of the screen measures the Center Region Temperature (Average). The Center Region Temperature (Average) is dynamically indicated within the color palette range indicator.

The color palette range indicator shows the complete temperature range of the active measured scene with the minimum and maximum temperature values of the scene. It is normal for the min/max temperature values to constantly change.

### 4.4.4 Using Full Thermal Mode

**Full Thermal Mode** displays objects at 100% thermal overlay opacity (full thermal image).

See [Startup / Shutdown \(On/Off\)](#) on page 8 for startup and battery charging information.

After startup, the default screen is displayed, see [Default Screen Features](#) on page 7 for feature and icon descriptions.

1. Press the **Up** control button repeatedly until 100% is displayed under the opacity icon. The imager is now in Full Thermal Mode (100% opacity).
2. Point the imager at the desired object(s) to be measured.



Figure 4-1

#### **Full Thermal Mode - Operation Options**

- Pull the **Screen Capture Trigger** to save an image of the active screen. See [Capturing and Saving Images](#) on page 32 for additional information.
- To change view settings (e.g. zoom, picture-in-picture, split-screen) see [Changing View Settings \(Live Mode\)](#) on page 10.
- To change the emissivity settings, see [Emissivity](#) on page 29. for additional information.
- See [Settings](#) on page 18 for information on all device settings.
- The thermal image is displayed using the color palette selected to define object temperatures. Use the color palette range indicator to determine the temperature of objects within the thermal image. To change the color palette settings, see [Color Palette](#) on page 24 for additional information.

### 4.4.5 Using Overlay Opacity Mode

Overlay Mode displays objects using visible light with a selectable thermal overlay opacity of 20, 40, 60 or 80%.

See [Startup / Shutdown \(On/Off\)](#) on page 8 for startup and battery charging information.

After startup, the default screen is displayed, see [Default Screen Features](#) on page 7 for feature and icon descriptions.

1. Press the **Up / Down** control buttons to toggle the opacity percentage level (under the opacity icon) between 20% and 80%.
2. Point the imager at the desired object(s) to be measured.

Typical examples (rear window defrost) of the overlay level settings are shown below

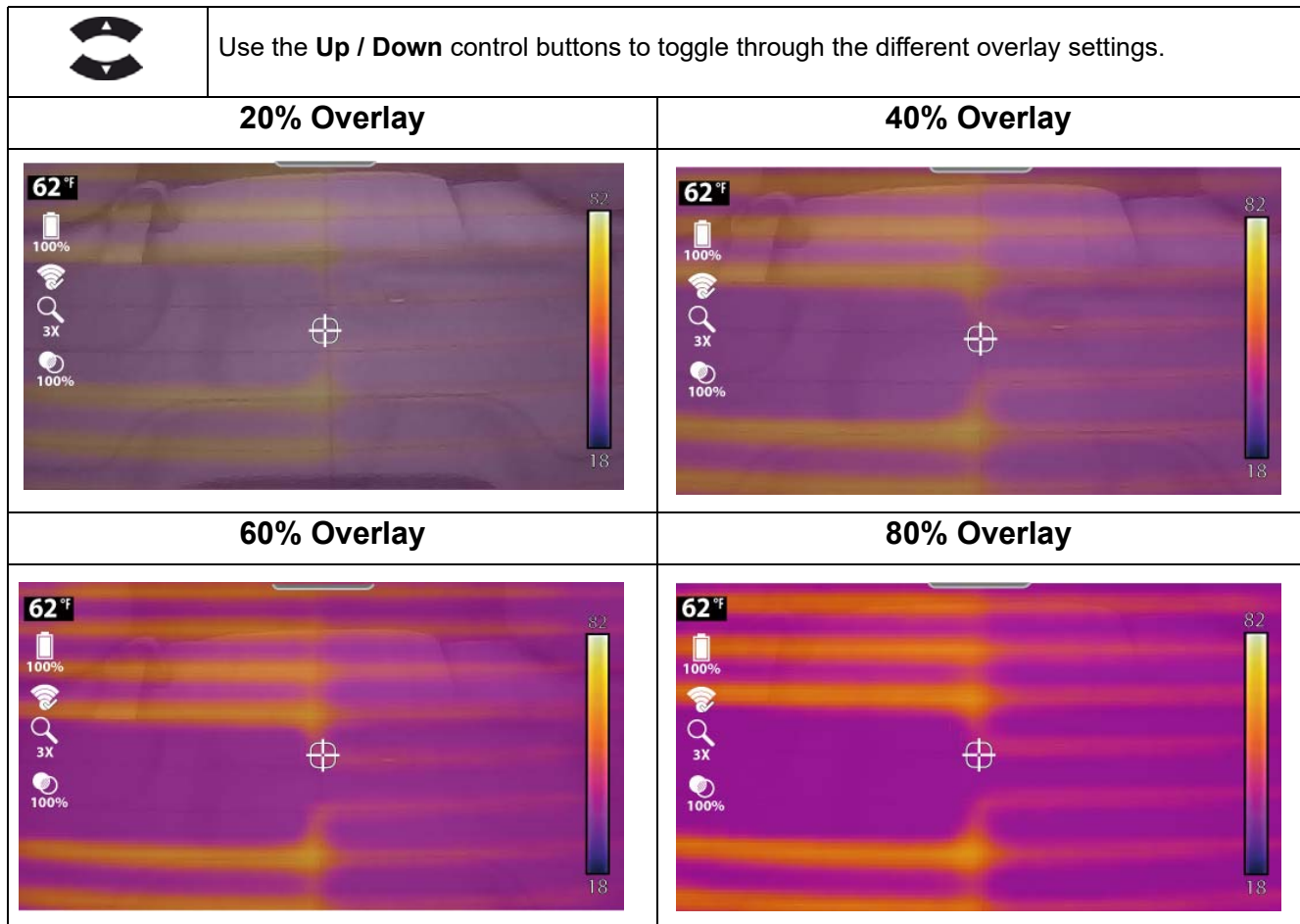

### Overlay Mode - Operation Options

- Pull the **Screen Capture Trigger** to save an image of the active screen. See [Capturing and Saving Images](#) on page 32 for additional information.
- Press the **N** button to start/stop video recording. See [Recording and Saving Video](#) on page 33 for additional information.
- Press the **Y** button to turn on/off the LED Spotlight, see [Using the LED Spotlight](#) on page 17.
- To change view settings (e.g. zoom, picture-in-picture, split-screen) see [Changing View Settings \(Live Mode\)](#) on page 10.
- To change the emissivity settings, see [Emissivity](#) on page 29. for additional information.
- See [Settings](#) on page 18 for information on all device settings.
- The thermal image is displayed using the color palette selected to define object temperatures. Use the color palette range indicator to determine the temperature of objects within the thermal image. To change the color palette settings, see [Color Palette](#) on page 24 for additional information.

## 4.4.6 Using Visual Light (Camera) Mode

**Visible Light Mode** displays objects at 0% thermal overlay opacity. This mode displays objects similar to a standard visible light digital camera.

See [Startup / Shutdown \(On/Off\)](#) on page 8 for startup and battery charging information.

After startup, the default screen is displayed, see [Default Screen Features](#) on page 7 for feature and icon descriptions.

1. Press the **Down** control button repeatedly until 0% is displayed under the opacity icon. The imager is now in Visual Light Mode (0% opacity).
2. Point the imager at the desired object(s).



Figure 4-2

### **Visual Light Mode - Operation Options**





- Pull the **Screen Capture Trigger** to save an image of the active screen. See [Capturing and Saving Images](#) on page 32 for additional information.
- Press the **N** button to start/stop video recording. See [Recording and Saving Video](#) on page 33 for additional information.
- Press the **Y** button to turn on/off the LED Spotlight, see [Using the LED Spotlight](#) on page 17.
- To change view settings (e.g. zoom, picture-in-picture, split-screen) see [Changing View Settings \(Live Mode\)](#) on page 10.
- See [Settings](#) on page 18 for information on all device settings.



### 4.4.7 Using the Menu (Menu Mode)

When the **Menu** button (Figure 4-3) is pressed, Live Mode switches to Menu Mode.

In Menu Mode control buttons function as follows:

| Button  | Menu Mode Button Operations  |
|---|--|
|  | <b>Video Recording - Enable / Disable video recording mode</b> (see <a href="#">Recording and Saving Video on page 33</a> )  |
|  | <b>LED Spotlight - On / Off</b> (see <a href="#">Using the LED Spotlight on page 17</a> ).   |
|  | <b>View Setting Options</b> - Use the Left / Right control buttons to toggle through the settings. See <a href="#">Changing View Settings (Live Mode) on page 10</a> .                           |
|  | <b>Overlay Setting Options</b> - (20 to 80% in 20% increments) Use the Up / Down control buttons to toggle through the settings. See <a href="#">Overlay Mode - Operation Options on page 13</a> |

3. Press the **Menu** button (Figure 4-3).



Figure 4-3

4. To select an option from the toolbar (Figure 4-4), press the **Left / Right** control buttons.
5. Press the **Y** button to open the selection.

An active selection is indicated by a white highlighted icon.



1. **Expert Tips Icon** - Opens the expert tips menu, see [Expert Tips on page 37](#).
2. **Image Gallery Icon** - Opens the gallery of saved images, see [Using the Gallery \(Viewing / Deleting\) on page 33](#).
3. **Delete Icon** - Use to delete saved images (shown grayed out), see [Using the Gallery \(Viewing / Deleting\) on page 33](#).
4. **Settings Icon** - Opens the device settings menu, see [Settings Menu on page 19](#).

Figure 4-4

**NOTES:**

When the toolbar icons are selected, they will change color from red to white to indicate the function is active.

Menu options and icons that appear grayed out (transparent), indicate that they are not applicable.

The last menu viewed is displayed when the **Menu** button is pressed.

- To select a menu option, press the **Up / Down** control buttons (Figure 4-5).  
If more options are available than can be displayed onscreen, use the **Down** button to scroll down through the options.
- When finished, press the **Menu** button to exit.

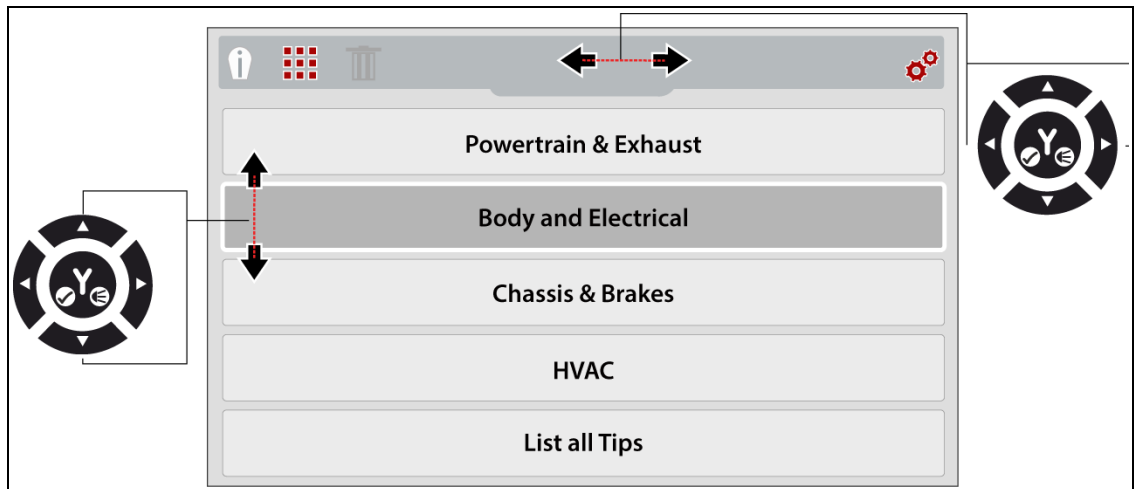



Figure 4-5

## 4.4.8 Using the LED Spotlight

An LED spotlight is provided to illuminate areas of low light when capturing visual images and video. Press the **Y** button (in Live mode) to turn the LED spotlight ON/OFF.

| Button  | Live Mode Special Button Operation |
|---|------------------------------------|
|  | LED Spotlight - On / Off           |

The spotlight has three intensity levels, to change the light level, see [Spotlight Intensity](#) on page 27.

**NOTE:**

When the battery reaches a low charge level (approximately one bar indication on icon), the LED flashlight is disabled. The spotlight will be functional again when the battery has been charged to approximately 30%. Always turn the spotlight off before and when charging the battery.

**NOTE:**

A fully charged battery pack can provide up to 4 hours of continuous operation. The battery discharge rate will vary depending on overall use and settings. To optimize battery life when using the spotlight, use the spotlight at brief intervals with a lower intensity level.

## 5.1 Main Topic Links

The following topics are described in this section:

- [Wi-Fi Connection](#)
  - [Connecting the thermal imager to a Wi-Fi network:](#)
  - [Disconnecting from a network, or remove password](#)
  - [Wi-Fi Status - Icon Identification](#)
- [ALTUS Setup](#)
- [Date and Time](#)
- [Color Palette](#)
- [Brightness](#)
- [Language](#)
- [Automatic Shutdown](#)
- [Navigation Tips](#)
- [Spotlight Intensity](#)
- [Thermal Camera Calibration](#)
- [Advanced](#)
  - [Temperature](#)
  - [Emissivity](#)
  - [Object Distance](#)
  - [Wi-Fi Status](#)
  - [Micro SD card check](#)
  - [About \(Factory Reset\)](#)

## 5.2 Settings Menu

Device settings can be changed using the Settings menu.

1. Press the **Menu** button (Figure 5-1).



Figure 5-1

2. Use the **Left / Right** control buttons to select the **Settings** icon from the toolbar (Figure 5-2).



Figure 5-2

3. Use the **Up / Down** control buttons to select an option from the menu.



**NOTE:**

You can return to Live mode at anytime by pressing the **Menu** button.

4. Press the **Y** button to open the selected setting option.

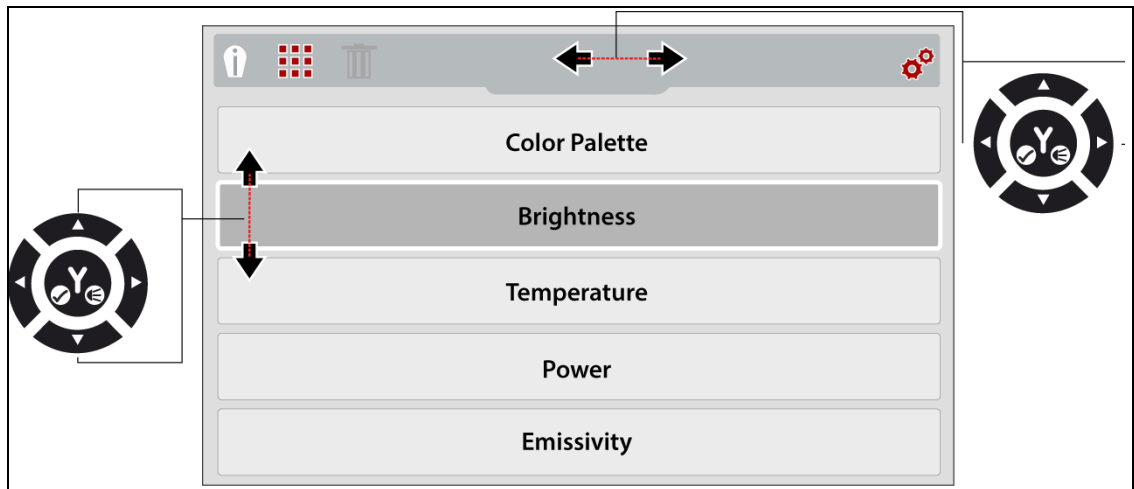

Figure 5-3 Settings Icon

## 5.2.1 Wi-Fi Connection

The diagnostic thermal imager is equipped with the ability to connect to a Wi-Fi network, however the connection is solely dedicated to our ALTUS cloud-based image storage/sharing website, see [ALTUS \(ALTUSDRIVE.com\) - Image Sharing/Storage](#) on page 41.

Before you can use ALTUS, Wi-Fi must be turned on and the device must be connected to a wireless network.



### Connecting the thermal imager to a Wi-Fi network:

Selecting **Wi-Fi Connection** from the settings menu allows you to turn Wi-Fi on/off and select a wireless network ([Figure 5-4](#)).

1. Turn on the thermal imager and press the **Menu** button.
2. From the toolbar select the **Settings** icon.
3. Select **Wi-Fi Connection** from the menu.
4. To turn Wi-Fi on/off, press the **UP** control button to select the **Wi-Fi Power** icon, then press the **Y** button to turn (toggle) Wi-Fi on/off ([Figure 5-4](#)).

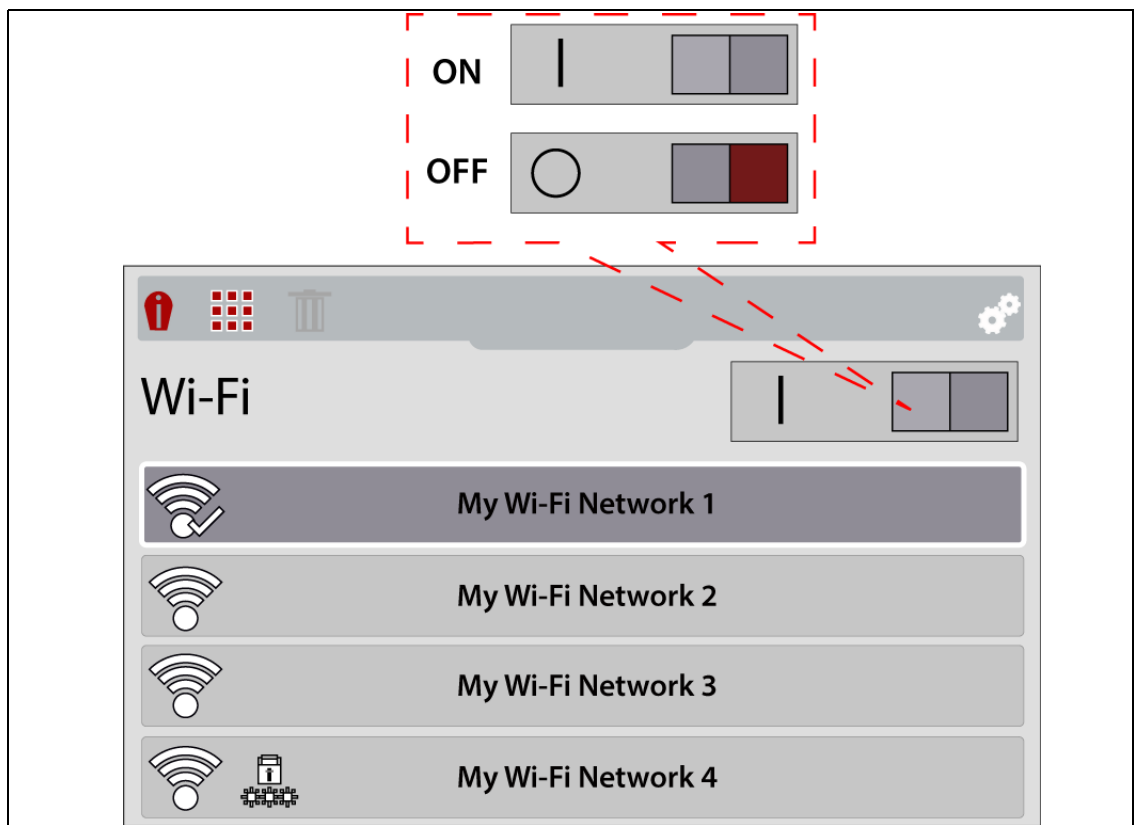



Figure 5-4 Wi-Fi On/Off / Network Selection

5. Press the **Down** control button to enter the Wi-Fi network list, then use the **Up / Down** control buttons to select a wireless network. Press the **Y** button to enable the selection ([Figure 5-4](#)).
6. If a password is required when choosing a secured (protected)  network, enter the password using the on-screen keyboard and the directional control buttons. Select the “**enter/ done**” key when finished ([Figure 5-5](#)).

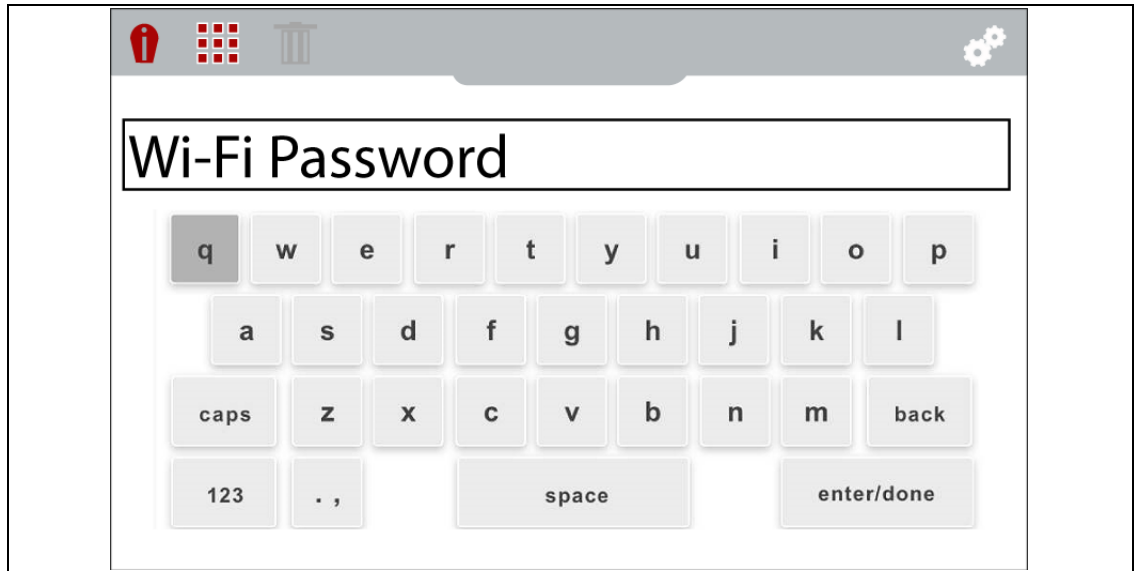

Figure 5-5 Wi-Fi Password Screen

When successfully connected to a Wi-Fi network, a check mark will display on the Wi-Fi icon.

7. A confirmation screen displays showing the device serial number, PIN and Code. These numbers are needed for ALTUS account setup (Figure 5-6), see [Registration - Getting Started](#) on page 42.

Use the QR code to open ALTUSDRIVE.com on your mobile device (Figure 5-6).

**IMPORTANT** - If you are a new owner of this tool, you must register this device with your ALTUS account in order to transfer files to your ALTUS account. If you do not register the device with your ALTUS account, captured files will be sent to the previous owners ALTUS account. If you do not have an ALTUS account, see [Registration - Getting Started](#) on page 42.



Figure 5-6 Wi-Fi Password Screen



**Disconnecting from a network, or remove password**

1. Turn on the thermal imager and press the **Menu** button.
2. From the toolbar select the **Settings** icon.
3. Select **Wi-Fi Connection** from the menu.
4. Select the connected network, and press the **Y** button.  
From the menu, select **Disconnect** or **Forget Password**.

**Wi-Fi Status - Icon Identification**

The following chart shows the WI-Fi icons used to indicate connection status.

|  |  |   |  |
|--|--|---|--|
| Wi-Fi - ON / Connected to network access point and Internet  |  | Wi-Fi - ON / Alternate available network access point         |  |
| Wi-Fi - ON / Not connected to network access point or Internet   |  | Wi-Fi - ON / Network access point password protected          |  |
| Wi-Fi - ON / Connected to network, not connected to Internet   |  | Wi-Fi - ON / Actively connecting to network access point      |  |
| Wi-Fi - OFF  |  | Wi-Fi - ON / Actively disconnecting from network access point |  |
| Wi-Fi Signal Strength (general):<br><b>Three bars</b> - Full Strength Signal<br><b>Zero bars</b> - Weak Signal |  |   |  |



## 5.2.2 ALTUS Setup

Selecting **ALTUS Setup** displays the following:

- Device Serial Number
- Code
- PIN
- ALTUSDRIVE.com QR code

This information is used when registering on ALTUSDRIVE.com.

See [ALTUS \(ALTUSDRIVE.com\) - Image Sharing/Storage](#) on page 41 for registration information..



Figure 5-7

### 5.2.3 Date and Time

Selecting **Date and Time** allows you to set the device system date and time (Figure 5-8).

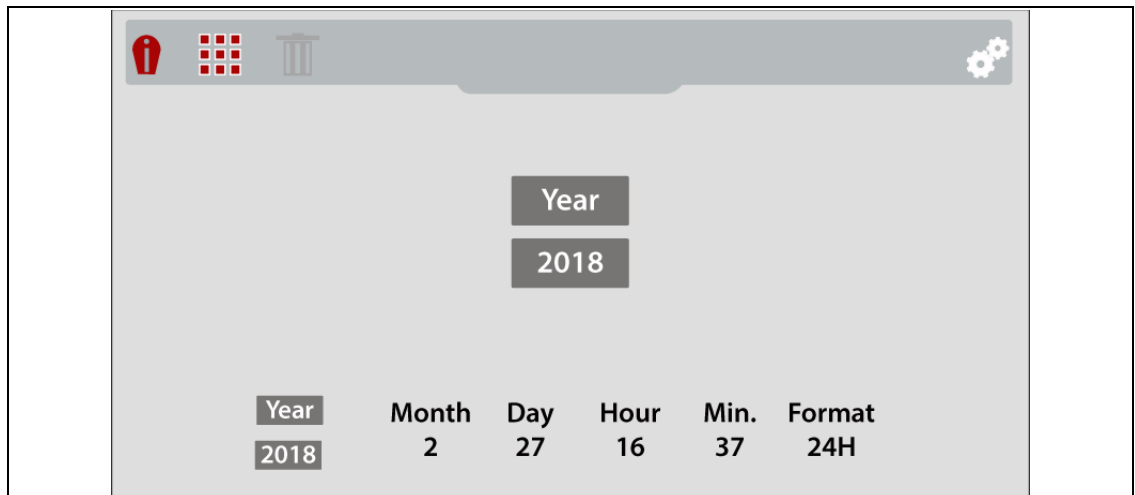

Figure 5-8 Date and Time Settings Screen



#### To set system date and time:

1. Use the **Up / Down** control buttons to select the year, month, day, hour and minute. Press the **Y** button after making each selection to continue to the next.
2. After all selections have been made, press the **N** button to return to the settings menu.

### 5.2.4 Color Palette

Different color palette themes can be used to help define (enhance) object temperatures onscreen by varying color ranges, contrast and brightness. Four color palette presets are available from the menu (Figure 5-9).

Use the **Up / Down** control buttons to make a selection from the menu, then press the **Y** button to enable the selection and return to the settings menu.

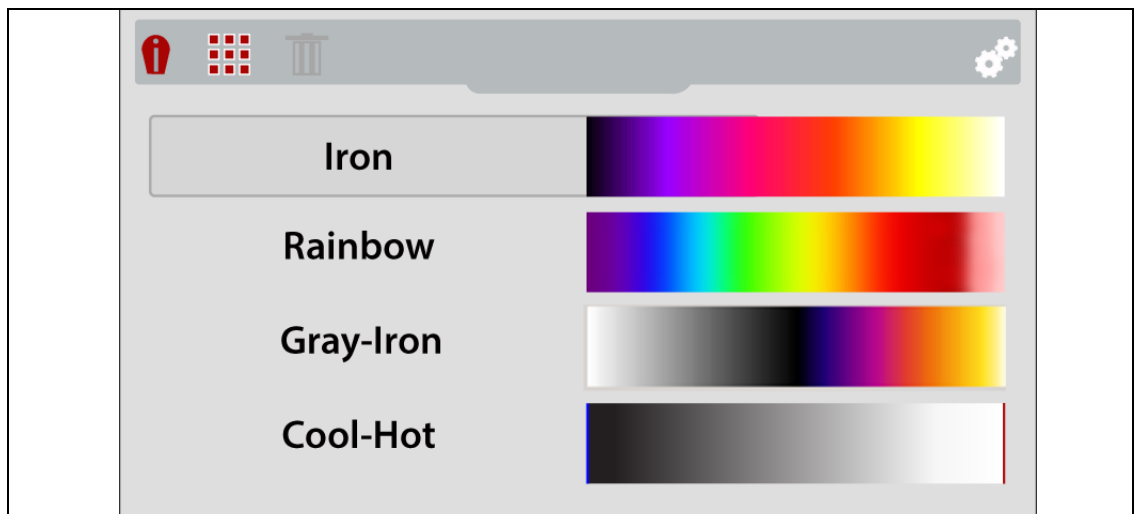

Figure 5-9 Color Palette Settings Menu

## 5.2.5 Brightness

The **Brightness** setting allows you to set the lighting level of the display (Figure 5-10).

Use the **Up / Down** control buttons to change the brightness setting, each press of incrementally changes the lighting level by 10%.

Press the **N** button to return to the settings menu.

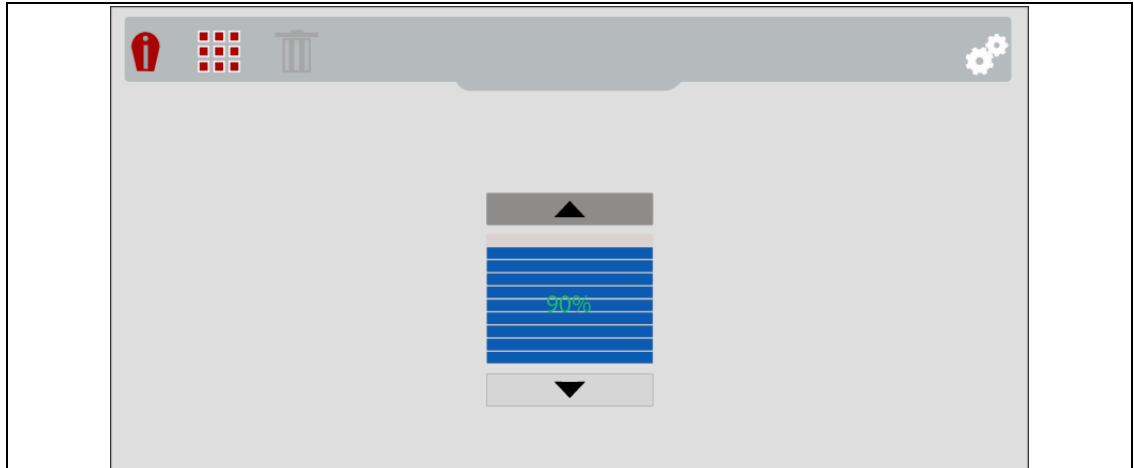

Figure 5-10 Brightness Settings Screen

## 5.2.6 Language

Selecting **Language** from the menu allows you to select the your preferred language (Figure 5-11).

Use the **Up / Down** control buttons to make a selection from the menu, then press the **Y** button to enable the selection and return to the settings menu.

Menu Options: **English, French, Spanish, Italian, Polish, Dutch, German, Portuguese (Brazil).**



Figure 5-11 Language Menu

### 5.2.7 Automatic Shutdown

The **Power** settings menu allows you to set the automated power off time. Four preset options are provided (Figure 5-12).

Use the **Up / Down** control buttons to make a selection from the menu, then press the **Y** button to enable the selection and return to the settings menu.

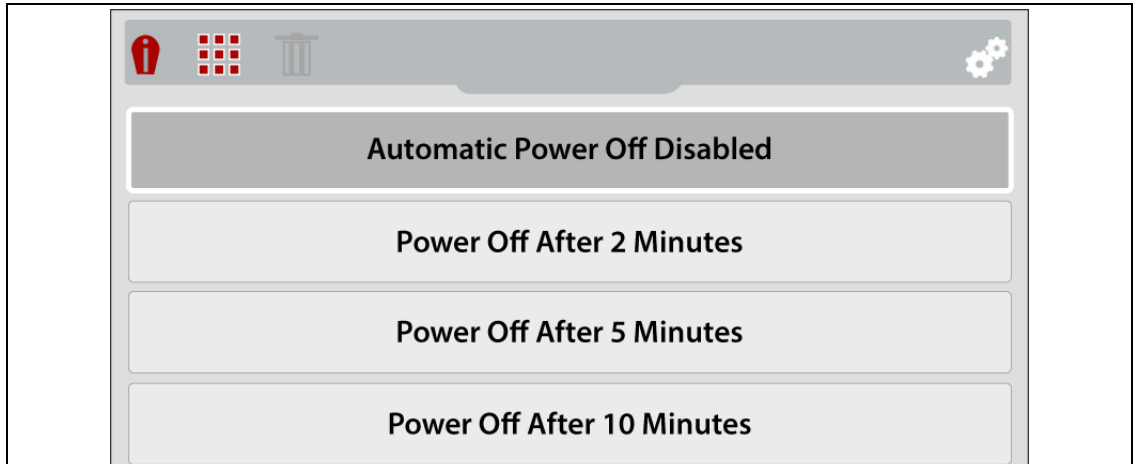

Figure 5-12 Power Settings Menu

### 5.2.8 Navigation Tips

Onscreen navigational tips are provided for select menu navigation procedures, to help you become familiar with the Thermal Imager menus. Each Tip will appear only once after turning on the Thermal Imager.

Selecting **Navigation Tips** from the settings menu allows you to turn on (enable), or turn off (disable) the automated navigational tips (Figure 5-13).

Use the **Up / Down** control buttons to make a selection (**On** or **Off**) from the menu, then press the **Y** button to enable the selection and return to the settings menu.

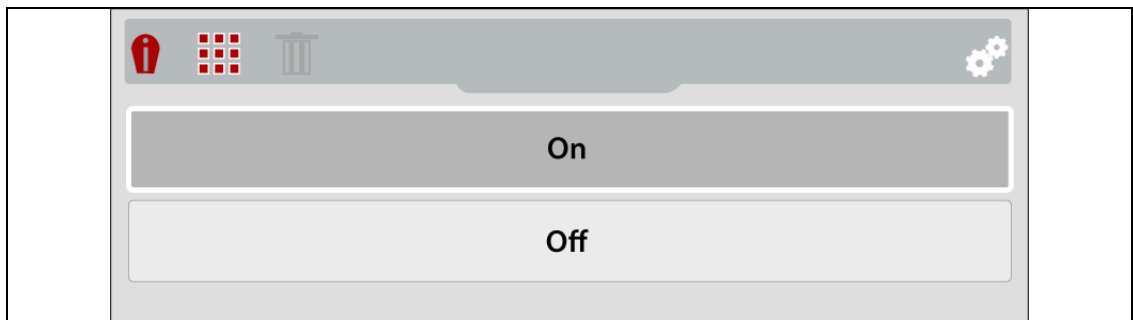

Figure 5-13 Navigational Tips Settings Menu

## 5.2.9 Spotlight Intensity

Selecting **Spotlight Intensity** allows you to adjust the brightness of the LED spotlight (Figure 5-14).

Three settings are provided:

- Low (Eco) - 7 lumens
- Medium - 12 lumens
- High - 22 lumens (default setting)

Use the **Up / Down** control buttons to make a selection from the menu, then press the **Y** button to enable the selection and return to the settings menu.

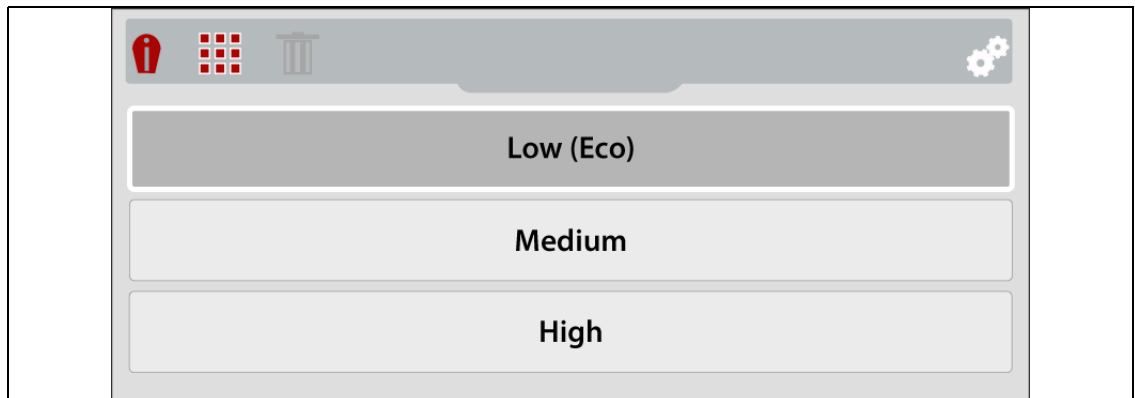

Figure 5-14 *Spotlight Intensity Menu*

### 5.2.10 Thermal Camera Calibration

As the temperature of the thermal sensor influences the measured values, the imager performs automatic calibrations during operation to calibrate the thermal imager for the current temperature of the sensor. Selecting **Thermal Camera Calibration** allows you to manually perform a calibration at anytime during operation.

#### Automatic Calibration

The Thermal Imager uses an automatic calibration feature to ensure consistent and accurate temperature measurements are provided.

Additional Information:

- A screen message (e.g. calibrating) is displayed during the automatic calibration process.
- An automatic calibration will occur when the thermal imager is turned on during “warm-up”.
- An automatic calibration will occur approximately every 5 minutes and once at every 3°C temperature change of the thermal sensor.
- An audible "click" may also be heard during calibration, and a temporary screen “freeze” occurs.
- A symbol is used to indicate calibration is about to occur (see following table):

| Example   | Description   |
|---|---|
|  | At one minute (or less) before a calibration occurs, a “~” symbol is displayed in front of the Center Region Temperature (Average) to indicate calibration is about to occur. |

### 5.2.11 Advanced

#### Temperature

The **Temperature** settings menu allows you to set the temperature unit of measure (°F or °C) ([Figure 5-15](#)).

Use the **Up / Down** control buttons to make a selection from the menu, then press the **Y** button to enable the selection and return to the settings menu.

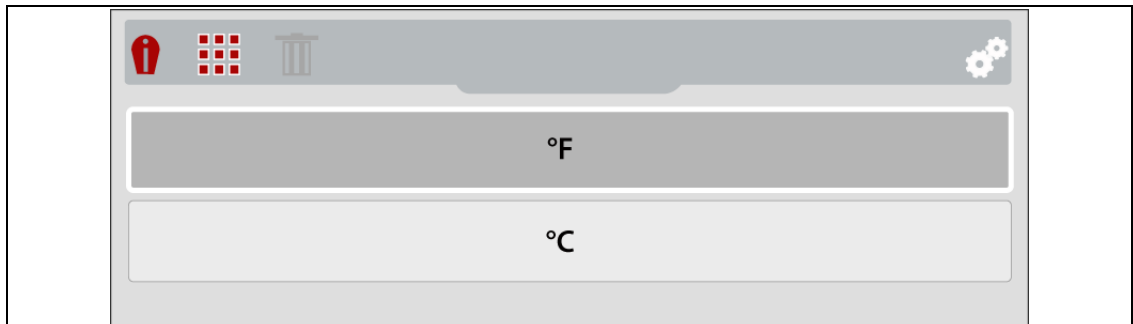

Figure 5-15 Temperature Settings Menu

## Emissivity

The Thermal Imager measures and displays the emitted infrared radiation from an object(s).

To accurately calculate temperature (from infrared radiation), the emissivity value of the object being measured must be entered. The emissivity value is used to effectively calculate the displayed temperature value.

Emissivity is the amount of radiation emitted from an object, compared to that of a perfect blackbody (standard of radiation) of the same temperature.

Emissivity can be effected by other factors (listed below), which is beyond the scope of this manual.

- Core material makeup
- Surface condition
- Temperature
- Angle of view
- Wavelength

As a general rule, objects and surfaces normally exhibit emissivity ranging from approximately 0.1 to 0.95. Materials with smooth (non oxidized) surfaces, usually range from 0.05 to 0.50, however these values may change if the surface is rough or oxidized.

The Thermal Imager is equipped with five common emissivity value presets ([Figure 5-16](#)). Choose the most applicable setting for your application.

Use the **Up / Down** control buttons to make a selection from the menu, then press the **Y** button to enable the selection, and return to the settings menu.

The default emissivity level setting is Plastic/Rubber, Painted Metal (flat) (0.95).



Figure 5-16 Emissivity Settings Menu

## Object Distance

Selecting **Object Distance** allows you to optimize the accuracy of the thermal imager, by setting the approximate distance to the object you are measuring.

Use the **Up / Down** control buttons to make a selection (**Near / Far**) from the menu, then press the **Y** button to enable the selection and return to the settings menu.

Options:

- **Near** - 1 to 3 feet (30.48 to 91.44 cm)
- **Far** - 3 to 10 feet (91.44 to 304.8 cm)



### NOTE:

The thermal imager uses two cameras to provide the blended (overlay) effect of the thermal image over the visual light image. As the two cameras view slightly different images due to their alignment with an object, when viewing objects that are close to the camera the image may appear mis-aligned. This visual effect of the position of an object that appears to differ when viewed from different positions is known as parallax.

When objects are viewed closer than 1 foot (30.48 cm) they will always display slightly mis-aligned, however as the imager is moved farther away from the object the misalignment decreases. Therefore, to optimize the accuracy of the thermal imager when used in close proximity of an object 1 to 3 feet (30.48 to 91.44 cm), the Object Distance setting should be set to **Near**.

---

## Wi-Fi Status

The Wi-Fi Status screen provides connection status indicators that can be used to troubleshoot connection issues. See [Wi-Fi Connection Status](#) on page 72.

## Micro SD card check

The micro SD card check function is used to check the file system integrity of the micro SD card. If errors are found during the check, this may indicate possible micro SD card damage which could cause an inoperative condition. For micro SD card support, contact Customer Support see [Customer Support Information](#) on page v.



## About (Factory Reset)

Selecting **About** displays hardware and software version information, and provides the option to reset the device to factory settings.

Select **Ok** to exit the screen.

Select **Factory Reset** to reset the following to their factory default settings (as shown):

- -Color Palette - Iron
- -Brightness - Level 50%
- -Language - English
- -Temperature Unit - Fahrenheit
- -Automatic Shutdown - Disabled
- -Emissivity - 0.95
- -Navigation Tips - Disabled
- -Spotlight Intensity - High
- -Object Distance - Near
- -Opacity Overlay Level - 60%
- -Zoom Level - 3X
- -Wi-Fi Enable - Enabled
- -Wi-Fi Password - Password is deleted

When Factory Reset is selected a confirmation screen is displayed, select the **Y** button to proceed with the reset or the **N** button to cancel.

If **Y** is selected a confirmation screen displays to indicate the reset was completed, and then the option to delete all (USERDATA folder) images and videos is provided, select the **Y** button to delete all images and videos or the **N** button to cancel. See [Transferring Files to a PC](#) on page 36 for additional information about the USERDATA folder.

## 6.1 Main Topic Links

The following topics are described in this section:

- [Capturing and Saving Images](#)
- [Recording and Saving Video](#)
- [Using the Gallery \(Viewing / Deleting\)](#)
- [Transferring Files to a PC](#)

For information on using ALTUS, see [ALTUS \(ALTUSDRIVE.com\) - Image Sharing/Storage](#) on page 41.

## 6.2 Capturing and Saving Images

Still images can be captured at anytime while in Live mode.

1. When operating in Live mode, pull and release the **Trigger** to capture and save an image file set of the active screen.

When the **Trigger** is pulled:

- An image file set is saved to the microSD card. The image file set includes three views of the captured image, a full thermal view (**T**), visual light view (**V**), and an opacity view (**X**). See [About Image File Names](#) on page 32 for additional information.
  - If applicable, the image file set is uploaded to your ALTUS account at ALTUSDRIVE.com, see [ALTUS \(ALTUSDRIVE.com\) - Image Sharing/Storage](#) on page 41.
2. After the image is saved, you can continue operation as normal, save another image, or view the image saved on the microSD card in the Gallery, see [Using the Gallery \(Viewing / Deleting\)](#) on page 33.

Approximately 15000 images or 225 video files can be saved to the microSD card. The overall total of images and videos that can be saved will vary and depends on number and size of the saved files.

### 6.2.1 About Image File Names

When an image is captured, the thermal imager automatically assigns a system generated ID (name) to each image in the saved file set. The following describes the image ID naming protocol:

| Media Type | Unique ID Number | Thermal Image View Type |   | Image File Format |
|------------|------------------|-------------------------|---|-------------------|
| IMG        | 0153             | X                       | Indicates one of the following:<br>Opacity View<br>Split Screen View<br>Picture-in-Picture View | BMP (Bitmap)      |
|            |                  | V                       | Visual Light View   |                   |
|            |                  | T                       | Full Thermal View   |                   |

All images are named as shown in the table above, with the 4 digit numeral being the unique identifier (e.g. IMG0153V.BMP).

## 6.3 Recording and Saving Video

Video can be captured at anytime while in Live mode.

1. To enter recording mode, press the **N** button once.  
A video mode indicator is displayed onscreen.
2. To start recording, pull the trigger once.  
When video is being captured the indicator flashes.  
Video recording automatically stops at 20 seconds.
3. To stop recording, pull the trigger once again.  
When recording is stopped, the video file is automatically saved on the microSD card in the Gallery using a (MOVxxxV.AVI) file naming format.
4. After the video is saved, you can continue operation as normal, save another video, or view the video saved on the microSD card in the Gallery, see [Using the Gallery \(Viewing / Deleting\)](#) on page 33.

Approximately 15000 images or 225 video files can be saved to the microSD card. The overall total of images and videos that can be saved to the microSD card will vary and depends on number and size of all files saved.

## 6.4 Using the Gallery (Viewing / Deleting)

### 6.4.1 Opening the Gallery and Selecting a File

When you save an image or video, it is stored in the Gallery on the microSD card. To open the Gallery:

1. Press the **Menu** button ([Figure 6-1](#)).



Figure 6-1 Menu Button

2. Select the **Gallery** icon from the toolbar ([Figure 6-2](#)).

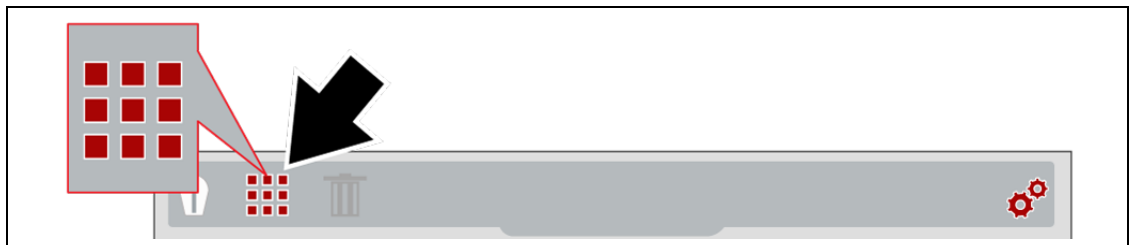
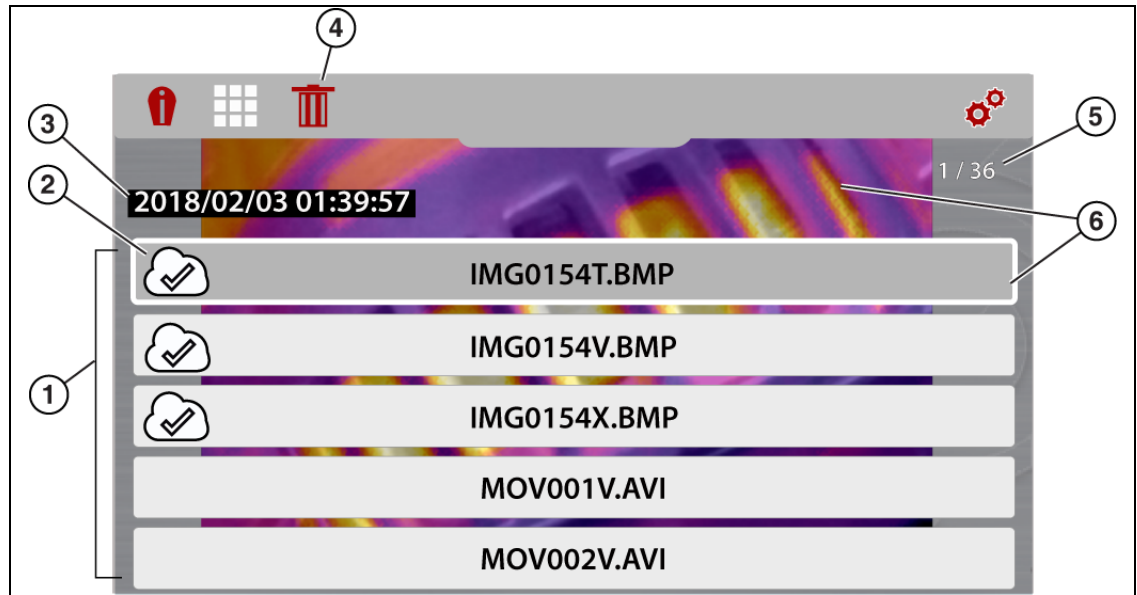

Figure 6-2 Image Gallery Icon

When the gallery opens, the Gallery list is displayed with the most recently saved file on top of the list ([Figure 6-3](#)).

3. Use the **Up / Down** control buttons to navigate through the Gallery list ([Figure 6-3](#)).

A file is selected when a highlighted box appears around the selection. A selected image can be partially seen in the background, as you scroll through the image menu (Figure 6-3).



1. File Menu
2. File Upload Status Icon
3. File Date/Time
4. Delete Icon
5. Current Image of Total indicator (e.g. 1 of 36)
6. Selected File (displays in background)

Figure 6-3 Image Gallery Screen

A file upload status icon is used on the file name selection (Figure 6-3) to indicate the current status of the file upload to ALTUS. See [ALTUS \(ALTUSDRIVE.com\) - Image Sharing/Storage](http://ALTUS(ALTUSDRIVE.com) - Image Sharing/Storage) on page 41 for additional information.

| File Upload Status Icons                    |  |
|---|--|
| File Not Uploaded or Waiting to be Uploaded |  |
| File Upload In Process                      |  |
| File Upload Complete                        |  |

## 6.4.2 Viewing Images in the Gallery

1. To view a file, select it from the Gallery list, then press the **Y** button.  
Typical example shown below:

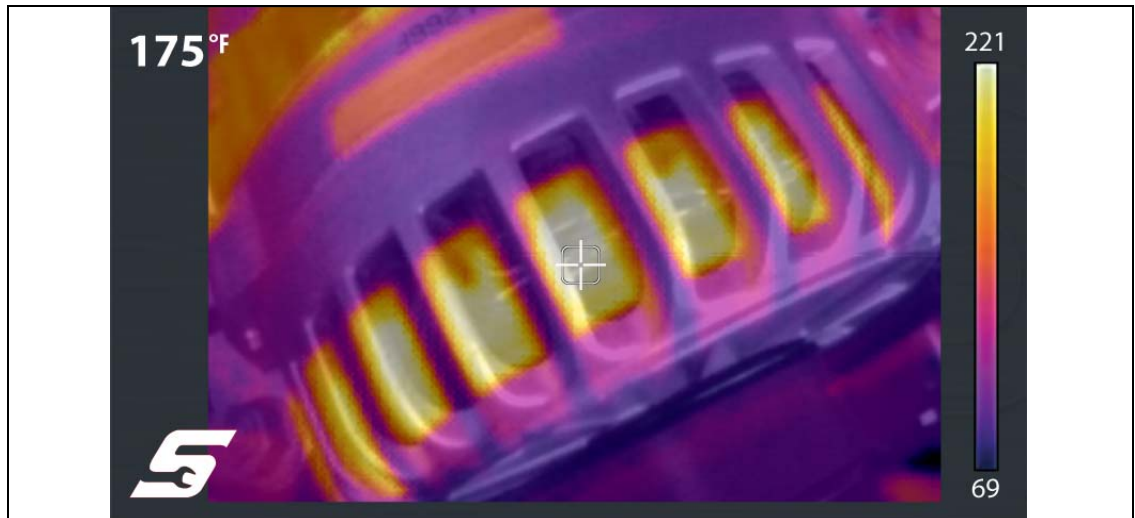

Figure 6-4 Saved thermal Image- Example

To select and view other files in the Gallery list, scroll through the list using the **Up / Down** control buttons.

2. Press the **N** button to return to the main menu.

## 6.4.3 Deleting Images from the Gallery

1. Open the Gallery, see [Opening the Gallery and Selecting a File](#).
2. Select the file to be deleted from the Gallery list.
3. Select the **Delete** (trash can icon) from the toolbar ([Figure 6-5](#)).



Figure 6-5 Delete Icon

4. Press the **Y** button to delete the file.

## 6.5 Transferring Files to a PC



### NOTE:

When the Thermal Imager is connected by USB cable to a PC, saving and viewing files is disabled. If the screen capture trigger is pulled, or the gallery icon is selected while the USB cable is connected to a PC, an error message is displayed. To resume saving images, disconnect the USB cable from the PC.

The Thermal Imager can be connected to a PC using the supplied USB cable. This allows you to transfer saved files to the PC.

1. Open the protective cover on top of the Thermal Imager, and connect the USB cable to the USB jack.
2. Turn the Thermal Imager on.
3. With your PC turned on, connect the USB cable to your PC.
4. The Thermal Imager will be recognized by your PC as an external storage device (e.g. USB Drive (E:), USB Drive (H:), etc.) (Figure 6-6).

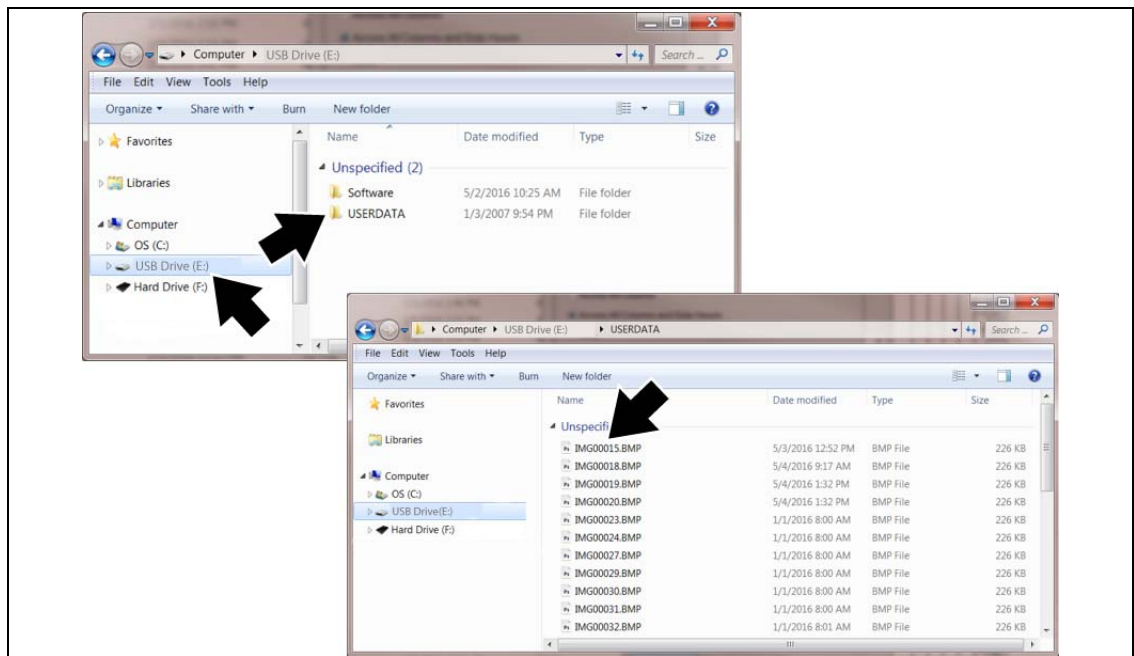

Figure 6-6 Typical PC screens

5. Using the standard Windows applications on your PC (e.g. Windows Explorer or Computer), select your saved files from the “**USERDATA**” folder on the Thermal Imager microSD card (Figure 6-6).  
Select a file (image/BMP or video/AVI) to open it, or copy or move files from the Thermal Imager to your PC.
6. When finished, (if required) perform any Windows procedures to “Safely Remove Hardware or Eject Media” to stop communication with the Thermal Imager.
7. Disconnect the USB cable from the PC, and the Thermal Imager.
8. Close the protective cover.

Removing the microSD card and using a memory card reader connected to your PC, is an alternate way to transfer images to your PC.

## 7.1 Expert Tips

The expert tips feature contains helpful troubleshooting tips, and (known good/bad) thermal images and video clips that are compiled from actual repairs from experienced technicians, and various independent sources.

The expert tips feature also includes a demonstration mode, that allows you to take a quick look at some of the thermal image examples and tips that are included. See [Demonstration Mode](#) on page 40 for additional information.

**NOTE:**

The tips provided are intended as guidance only.

---

Expert tips menu options include various component tips (approximately 70 +) from the following systems:

- Powertrain and Exhaust
- Body and Electrical
- Chassis and Brakes
- HVAC

Other options available from menu:

- List All Tips - Lists all the tips from the systems shown above.
- Demonstration - [Demonstration Mode](#) on page 40

When the Thermal Imager is connected by USB cable to a PC, the expert tips feature is disabled. If the expert tips icon is selected while the USB cable is connected to a PC, an error message is displayed. To resume using expert tips, disconnect the USB cable from the PC.

**To access expert tips:**

1. Press the **Menu** button ([Figure 7-1](#)).



Figure 7-1

The menu screen slides open from the top of the screen.

**NOTE:**

You can return to Live mode at anytime by pressing the **Menu** button.

---

2. (If needed) Use the **Left / Right** control buttons to select the **Expert Tips** icon from the toolbar ([Figure 7-2](#)).

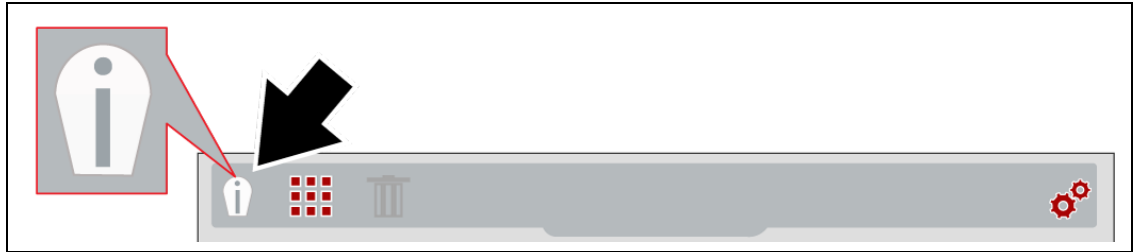

Figure 7-2 Expert Tips Icon

- Use the **Up / Down** control buttons to select a system, then press the **Y** button to open the menu.

**NOTE:**

Press the **N** button at anytime to go back to the last menu.

- Select an option from the component menu (Figure 7-3), then press the **Y** button to view the selection results. Additional sub-menu selections may be required depending on the selection.

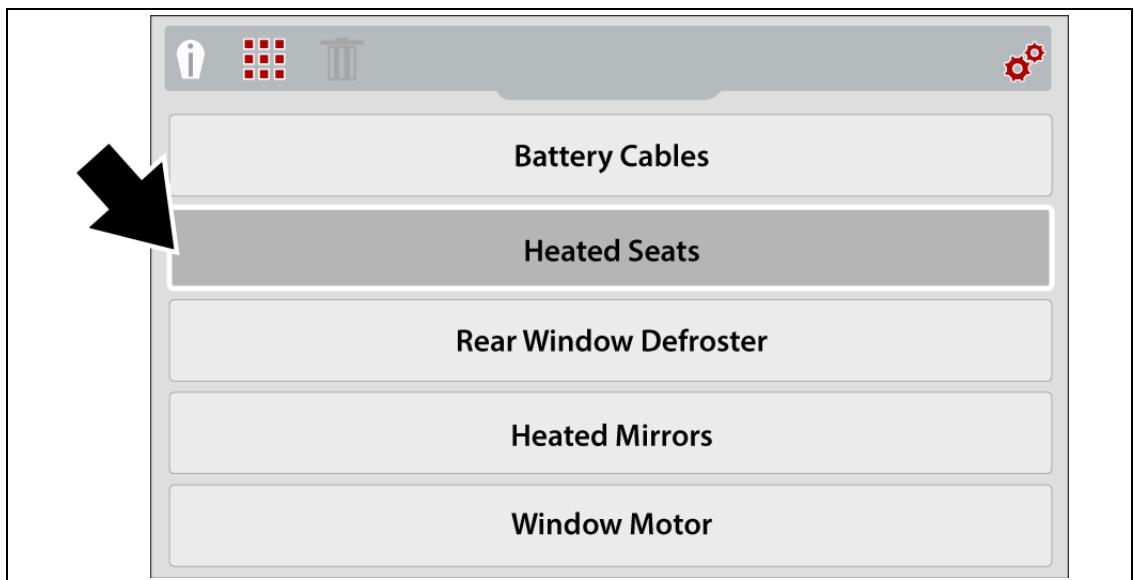

Figure 7-3 Component Menu

- Results are displayed (Figure 7-4). Use the **Up / Down** control buttons to scroll through the results. The results are identified as:
  - **Know Good** - indicates the thermal image or video clip shown represents a known good component, for comparison
  - **Known Bad** - indicates the thermal image or video clip shown represents a known bad component, for comparison
  - **Tip** - displays a general troubleshooting tip about the system or component





**NOTE:**

Tips and/or reference images may not be available for all components.

Expert tip screen examples are shown in [Figure 7-4](#).

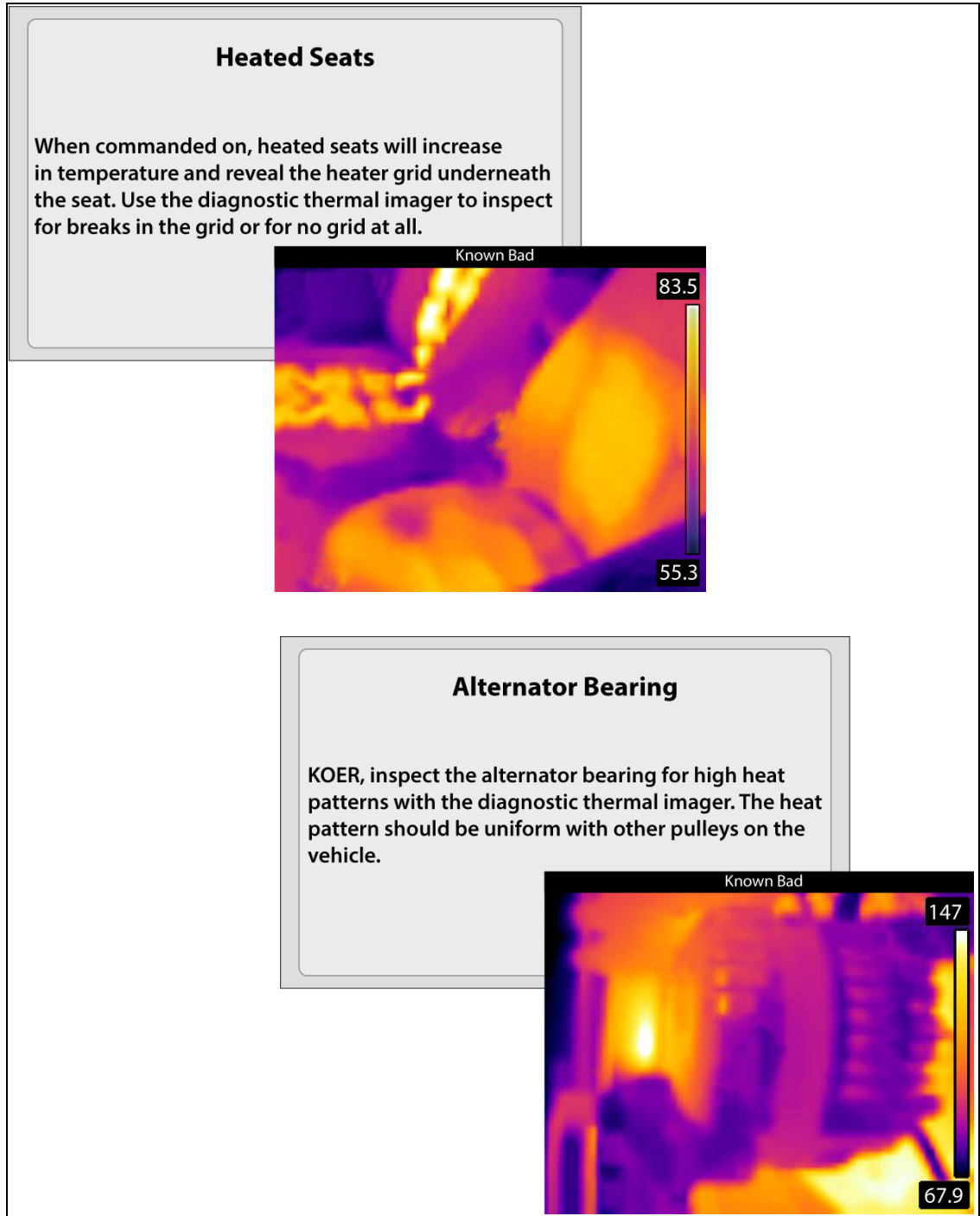

Figure 7-4

- When finished, press the **N** button to return to the expert tips menu, or press the **Menu** button to return to Live mode.

## 7.2 Demonstration Mode

The expert tips menu includes a Demonstration option, which allows you to quickly demonstrate and view sample thermal images, video clips and expert tips.



### To use Demonstration:

1. From the expert tips menu, select **Demonstration** (Figure 7-5). See [Expert Tips](#) on page 37 for navigation to the expert tips menu.

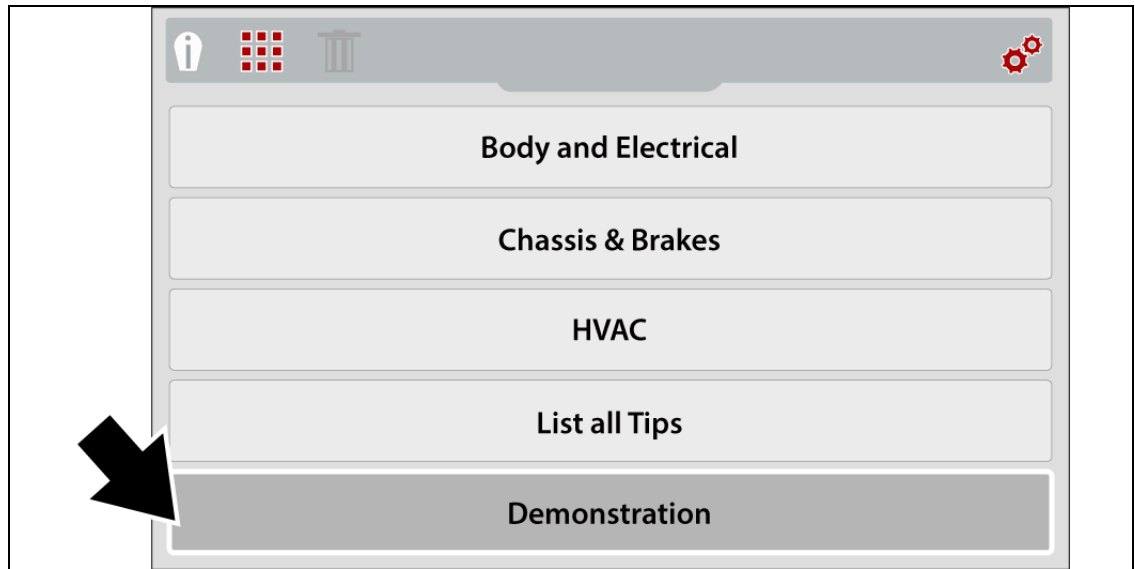

Figure 7-5

A thermal image or video clip example will appear on the screen (Figure 7-6).

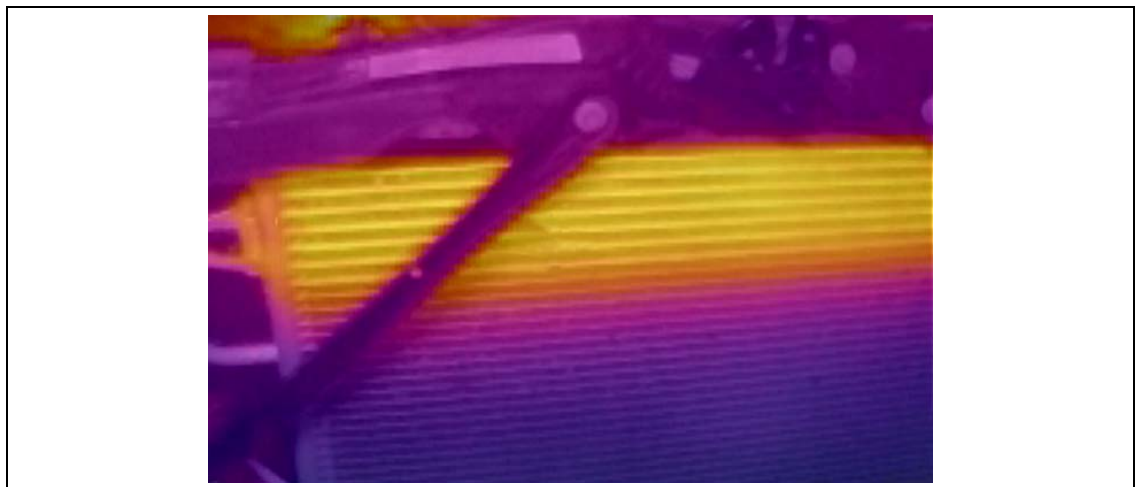

Figure 7-6 Demonstration - Thermal Image Video Example

2. Select the **Down** button to scroll through various expert tips



### NOTE:

Scrolling of examples will restart again, after the last image/tip is selected.

3. When finished, press the **N** button to return to the expert tips menu, or press the **Menu** button to return to Live mode.

# ALTUS (ALTUSDRIVE.com) - Image Sharing/Storage

The Diagnostic Thermal Imager Elite includes a built-in feature that automatically transfers captured images to ALTUS (ALTUSDRIVE.com).

ALTUS is a mobile-friendly cloud-based application designed specifically for technicians to store, organize and share diagnostic information.

## 8.1 Main Topic Links

The following topics are described in this section:

- [Registration - Getting Started](#)
- [Using ALTUS](#)
  - [Navigating ALTUS \(Toolbars\)](#)
  - [My Files](#)
    - [File Detail \(Tags\)](#)
    - [Sharing/E-mail an Individual Image \(Link icon\)](#)
    - [Sharing all Images \(Share My Gallery\)](#)
  - [Search](#)
  - [Favorites](#)
  - [Profile](#)
  - [Logging Out of ALTUS](#)

## 8.2 Key Features

- Automatically transfer captured thermal images to your ALTUS account on ALTUSDRIVE.com.
- Access your online thermal image gallery using your mobile device or PC.
- Share/send individual images or your entire gallery via e-mail.
- Download images to your PC (transfer/print/share).
- Tag images (attach descriptive text) to help you search your image gallery.
- Add images to Favorites for easy recall.
- Use the Search function to quickly find images in your gallery by user defined Tag, Description and Image Title text.

## 8.3 Important Notes

- To use ALTUS, Internet access, ALTUS account registration and thermal imager Wi-Fi connection are required.
- The thermal imager only transfers image files to ALTUS, not video files.
- ALTUSDRIVE.com is continuously monitored for inappropriate content. Abuse (as determined by moderator) will result in account deactivation.

**IMPORTANT** - If you are a new owner of this tool, you must register this device with your ALTUS account in order to transfer files to your ALTUS account. If you do not register the device with your ALTUS account, captured files will be sent to the previous owners ALTUS account. If you do not have an ALTUS account, see [Registration - Getting Started](#) on page 42.

## 8.4 Registration - Getting Started

To use ALTUS:

- The thermal imager must be connected to a Wi-Fi network
- Registration is required online
  - If you are a new user, you will need to create a new account, see [ALTUS - New User Registration](#).
  - If you already have a SureTrack® account, see [ALTUS - SureTrack User Setup](#).

### 8.4.1 ALTUS - New User Registration



If you are a new user, follow these steps to register and create a new account:



---

**NOTE:**

Account setup is only required one time.

---

1. Connect the thermal imager to a Wi-Fi network, see [Wi-Fi Connection](#) on page 20.
2. Write down the Serial Number, PIN and Code that are displayed when the device connects to the Wi-Fi network, or leave the screen displayed. Codes can also be found in the Settings menu, see [ALTUS Setup](#) on page 23.
3. Using a mobile device or PC, visit <https://ALTUSDRIVE.com> and select **Create Individual Account** from the Login screen.
4. Enter the required information and create a **Username** and **Password**, then select **Create**.
5. At the “Success” confirmation screen, select **Done**.
6. Log in using your **Username** and **Password**.
7. Answer the security questions, then select **Submit**.
8. From Technician Profile Manager select the **Device Management** tab.
9. Select **Add Device**, then enter your **Serial Number**, **PIN**, **Code**, and Device Name and select **Save** when done.
10. Log out of Profile Manager, then select the **ALTUS Home Page** browser tab to get started.
11. Turn the thermal imager off, and then on.
12. See [Using ALTUS](#).

Your Diagnostic Thermal Imager is now registered to your ALTUS online account. Images will be automatically sent (only when connected to Wi-Fi) to your online account from the device.



---

**NOTE:**

If the device is not connected to a Wi-Fi network when the images are taken, they will not be sent to your ALTUS account. Wi-Fi connection is required to upload the images to ALTUS.

---

## 8.4.2 ALTUS - SureTrack User Setup



**If you already have a SureTrack account, follow these steps to register and setup your ALTUS account:**

From a PC or mobile device:

1. Connect the thermal imager to a Wi-Fi network, see [Wi-Fi Connection](#) on page 20.
2. Write down the Serial Number, PIN and Code that are displayed when the device connects to the Wi-Fi network, or leave the screen displayed. Codes can also be found in the Settings menu, see [ALTUS Setup](#) on page 23.
3. Using a mobile device or PC, visit <https://ALTUSDRIVE.com> and select **Login** (upper right screen).
4. Log in using your SureTrack **Username** and **Password**.
5. Open the **Profile Manager** (additional login may be required).
6. From the **Device Management** tab, select **Add Device**.
7. Enter your **Serial Number, PIN, Code**, and **Device Name**.
8. Log out of Profile Manager, then select the **ALTUS Home Page** browser tab to get started.
9. Turn the thermal imager off, and then on.
10. See [Using ALTUS](#).

Your Diagnostic Thermal Imager is now registered to your ALTUS online account. Images will be automatically sent (only when connected to Wi-Fi) to your online account from the device.



---

**NOTE:**

If the device is not connected to a Wi-Fi network when the images are taken, they will not be sent to the ALTUS account. Wi-Fi connection is required to upload the images to ALTUS.

---

## 8.5 Using ALTUS

To use ALTUS:

- An ALTUS account is required, see [Registration - Getting Started](#) on page 42.
- The thermal imager must be connected to a Wi-Fi network, see [Wi-Fi Connection](#) on page 20.



### Logging in to ALTUS (registered user):

1. Using your mobile device or PC visit [ALTUSDRIVE.com](http://ALTUSDRIVE.com).
2. Select the **Login** icon ([Figure 8-1](#)).

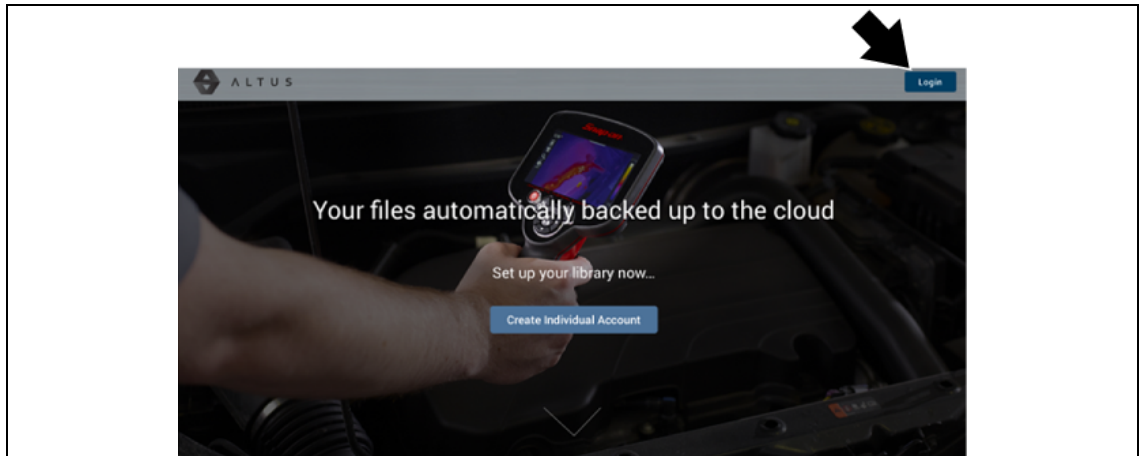

Figure 8-1

3. Log in using your **Username** and **Password** ([Figure 8-2](#)).

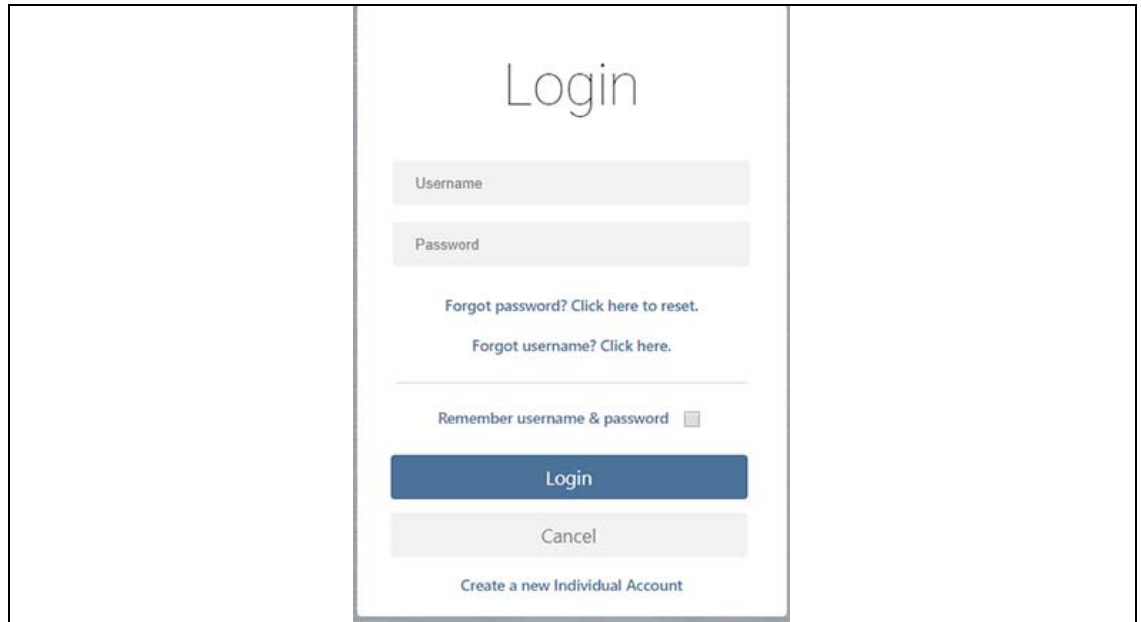

Figure 8-2

## 8.5.1 Navigating ALTUS (Toolbars)

The upper and lower toolbars are available from all screens.

The upper toolbar includes a menu icon (right side) (Figure 8-3). This menu allows you to:

- [Sharing all Images \(Share My Gallery\)](#), see page 50



Figure 8-3

The lower toolbar (Figure 8-4) includes the following links:

- [My Files](#), see page 46
- [Search](#), see page 51
- [Favorites](#), see page 52
- [Profile](#), see page 53



Figure 8-4

## 8.5.2 Quick Reference (ALTUS Operation)

**Downloading Files** - Select the menu icon on the image card (upper right), then select **Download** from the menu options. See (callout #4) in [My Files](#) on page 46.

**Printing Files** - Select the menu icon on the image card (upper right), then select **Download** from the menu options (see callout #4 in [My Files](#) on page 46), once downloaded print the file from your device. Alternate Method - open the file in a new browser tab (see [File Detail \(Tags\)](#) on page 47) and use the browser viewer tools to print the file. Note: All browsers may not support this feature.

**Sharing Individual Files** - Select the link icon on the image card (lower center), then select **Copy to Clipboard** from the pop-up window. See [Sharing/E-mail an Individual Image \(Link icon\)](#) on page 49.

**Sharing the Entire Gallery of Files** - Select the menu icon from the upper toolbar (upper right), then select **Copy to Clipboard** from the pop-up window. See [Sharing all Images \(Share My Gallery\)](#).

### 8.5.3 My Files

My Files displays all the images uploaded from the thermal imager (Figure 8-5). Each image is displayed in a navigation card.



Figure 8-5

1. **Image Upload Date** - Images are displayed with the most recent uploads at the top. The Image Upload Date is displayed at the upper left of the image(s). The date is shown once at the top of the series of images, scroll up / down to see all files within a specific date.
2. **Image File Name** - See [File Detail \(Tags\)](#) on page 47 for additional information.
3. **Your Account Username (and timestamp)** - See [Account](#) on page 54 for additional information. The timestamp indicates the date/time the file posted on ALTUSDRIVE.com
4. **Menu Icon** - options:
  - **Download** - Select to download the image to your device.
  - **Delete** - Select to delete the image from ALTUS.
5. **Favorites Icon** - See [Favorites](#) on page 52 for additional information.
6. **Link icon** - See [Sharing/E-mail an Individual Image \(Link icon\)](#) on page 49 for additional information.

Selecting an image opens the image File Details. The File Detail screen allows you to see alternate views of an image and edit image metadata. See [File Detail \(Tags\)](#) on page 47.



### File Detail (Tags)

As shown in [Figure 8-6](#) selecting (touching) an image from My Files opens the image File Detail card. Selecting the image again opens that image in a new browser tab.

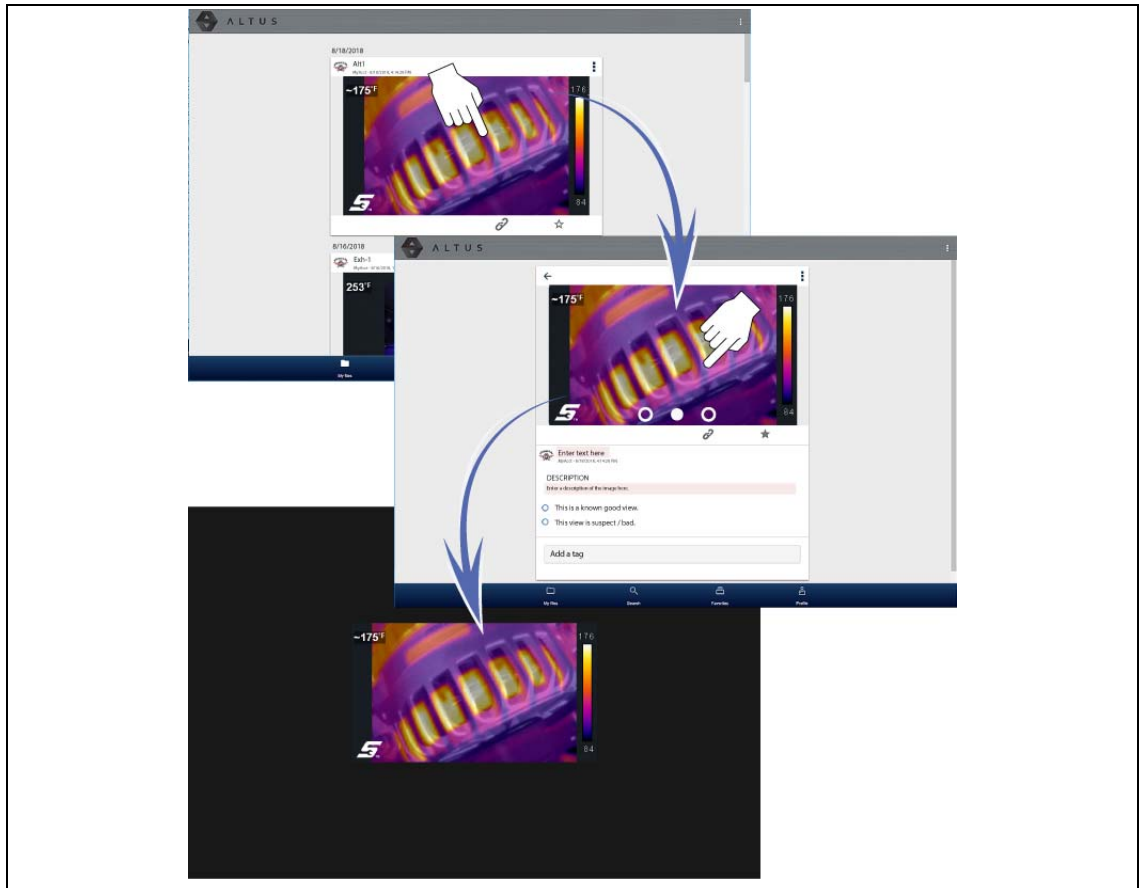

Figure 8-6

The following describes File Detail card features.



Figure 8-7

1. **Back Icon** - Returns to My Files
2. **Page Indicators (View Alternate Versions)** - Select the page indicators to see three alternate views of the same image, (1) visual light, (2) opacity and (3) full thermal.
3. **Image Name** (user entered searchable text) - Select the image file name to open the editor. Enter text (alphanumeric) in the field as desired.
4. **Your Account Username (and timestamp)** - See [Account](#) on page 54 for additional information. The timestamp indicates the date/time the file posted on ALTUSDRIVE.com
5. **Description** (user entered searchable text) - Enter text (alphanumeric) in the description field as desired.
6. **Known Good / Bad Checkboxes** (user defined and searchable) - Selecting a checkbox automatically creates a tag (e.g. #good) and is displayed in the Active Tag(s) field.
7. **Tag** (user entered searchable text) - Enter text (alphanumeric) in this field as desired. Tagging an image allows you to associate (tag) descriptive text to an image. Tagging can be used to associate multiple images with a common tag. The tag text then can be used when performing a search to find all images with the same tag. Each text entry (word) that is separated by a space (return) is added as a tag, and is displayed in the Active Tag field.
8. **Active Tag(s)** - Displays the active tag(s). Tags can include the “good” or “bad” entry from the Known Good / Bad checkboxes, and text entered in the Image Name, Description and Tag fields. Each entry is automatically preceded with the “#” symbol.

### About Image File Names

When an image is captured, the thermal imager automatically assigns a system generated ID (name) to each image in the saved file set. The following describes the image ID naming protocol:

| Media Type | Unique ID Number | Thermal Image View Type |   | Image File Format |
|------------|------------------|-------------------------|---|-------------------|
| IMG        | 0153             | X                       | Indicates one of the following:<br>Opacity View<br>Split Screen View<br>Picture-in-Picture View | BMP (Bitmap)      |
|            |                  | V                       | Visual Light View   |                   |
|            |                  | T                       | Full Thermal View   |                   |

All images are named as shown in the table above, with the 4 digit numeral being the unique identifier (e.g. IMG0153V.BMP).

### Sharing/E-mail an Individual Image (Link icon)

To share an image:

1. Select the **Link icon** (Figure 8-8) on the image card.



Figure 8-8

2. Select **Copy to Clipboard** (Figure 8-9) from the pop-up window.

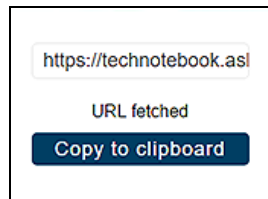

Figure 8-9

3. Open your (e-mail, text, social media, etc.) app and paste the URL into a message to share with others.

The URL link that is sent only displays:

- The Image
- Image Name
- Your User Name
- Date Image was posted
- Image Description

## Sharing all Images (Share My Gallery)

To share your entire gallery (all files in My Files):

1. Select the **Menu** icon (Figure 8-10) from the upper toolbar.



Figure 8-10

2. Select **Share My Gallery**.
3. Select **Copy to Clipboard** (Figure 8-11) from the pop-up window.

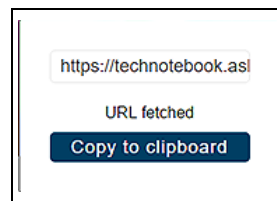

Figure 8-11

4. Open your (e-mail, text, social media, etc) app and paste the URL into a message to share with others.

The URL link that is sent is only displays:

- The Images
- Image Names
- Your User Name
- Date the Images were posted
- Image Descriptions

## 8.5.4 Search

The Search screen allows you to perform text searches on all uploaded files and view the results.

To search for a specific file or set of files, enter a **search term** in the search box and select the **magnifying glass** icon (Figure 8-12) (or press Enter).

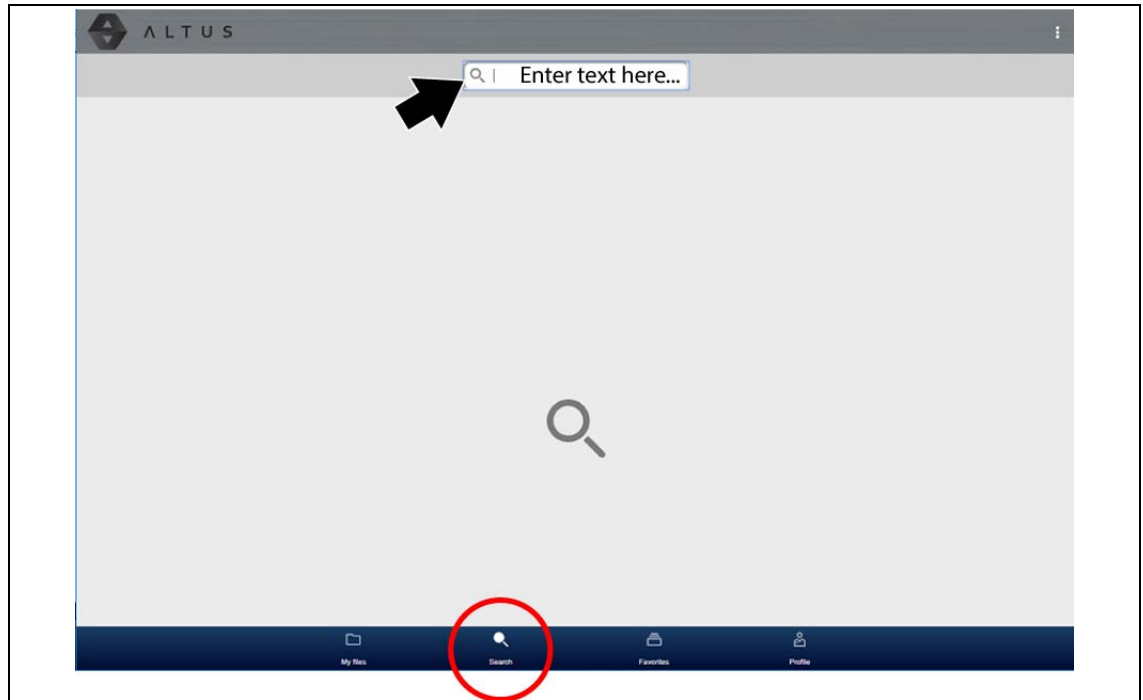

Figure 8-12

Search queries the following to find results:

- **Image File Name** - name can be either system assigned or user assigned
- **Known Good / Bad Checkboxes** - selecting a checkbox automatically creates a searchable tag (e.g. good or bad)
- **Description** - user entered text
- **Tag** - user entered text

See [File Detail \(Tags\)](#) on page 47 for additional information on the above “user entered” text.



### 8.5.5 Favorites

The Favorites screen displays all the images selected as favorites (Figure 8-13).



Figure 8-13

To set a file as a "Favorite", select the **Favorite** icon (star symbol) to highlight the icon.

| Description    | Icon  |
|----------------|---|
| Favorite (on)  |  |
| Favorite (off) |  |

The Favorites icon can be selected/deselected at anytime when displaying files.

## 8.5.6 Profile

The Profile screen allows you to:

- Open Profile Manager ([Figure 8-14](#)), see [Using Profile Manager](#) on page 53
- Logout of ALTUS, see [Logging Out of ALTUS](#) on page 57

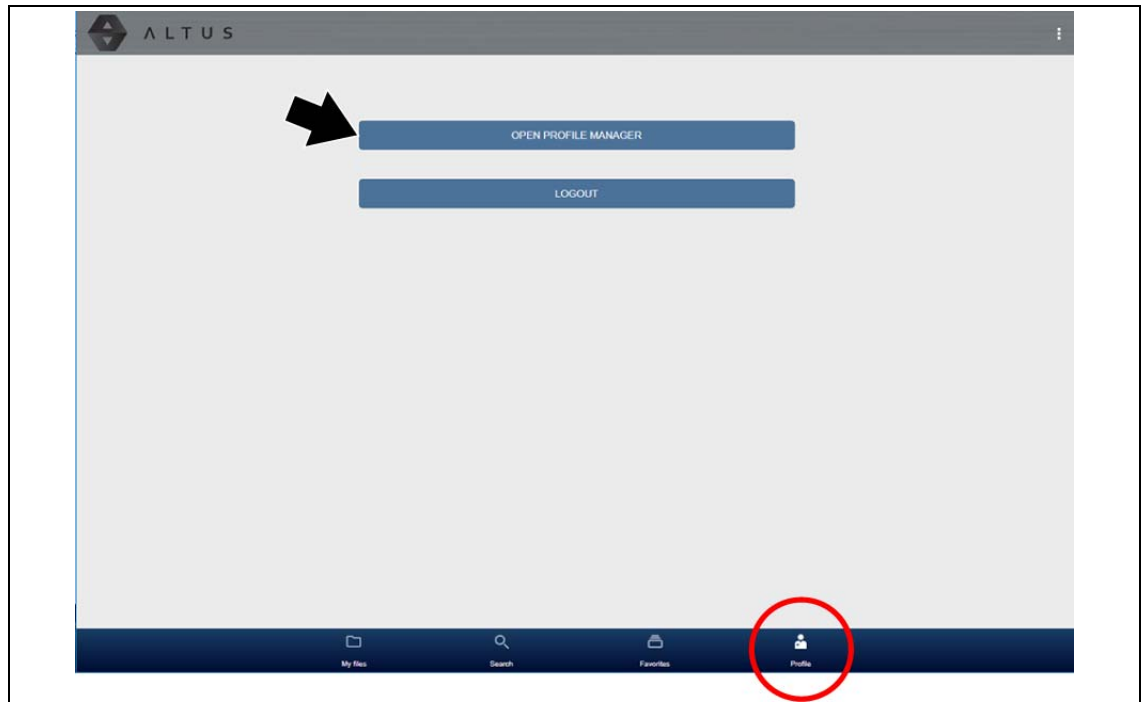

Figure 8-14

### Using Profile Manager

To open the Profile Manager screen, select **Profile** from lower toolbar, then select **Open Profile Manager** ([Figure 8-14](#)).



#### NOTE:

Profile Manager opens a new browser tab. To return to ALTUS after logging out of Profile Manager, you must select the ALTUS Home Page browser tab.

Enter your **Username** and **Password** at the Login screen.

If you are a SureTrack user, please note that Profile Manager is the same as your SureTrack Profile Manager. Any changes you make will also be reflected in your SureTrack account.

Profile Manager includes five tabbed categories to help you manage your account information:

- [Account](#) on page 54
- [Personal Information](#) on page 55
- [Expertise](#) on page 55
- [Profile Picture](#) on page 56
- [Device Management](#) on page 56

**Account**

This screen manages the following account information (Figure 8-15):

- Authorization Key (not required for ALTUS account registration)
- Account Expiration Date
- Shop Nickname
- Email
- Username
- Password

The screenshot displays the 'Technician Profile Manager' interface. On the left is a navigation menu with options: Account, Personal Information, Expertise, Profile Picture, and Device Management. The main content area is titled 'Your Name' and includes a profile picture placeholder with a logo. Below the name, it indicates 'New Member' and 'Activation Mode' (marked as a required field). There are input fields for 'Authorization Key' and 'Account Expiration Date'. A 'Shop Nickname' field is also present. Under the 'Online Profile' section, there are fields for 'Email' and 'Email Confirm' (both marked as required), and a 'Username' field. At the bottom right, there are 'Cancel' and 'Save' buttons.

Figure 8-15



### Personal Information

This screen manages the following personal account information (Figure 8-16):

- First Name
- Last Name
- City
- State
- Zip Code

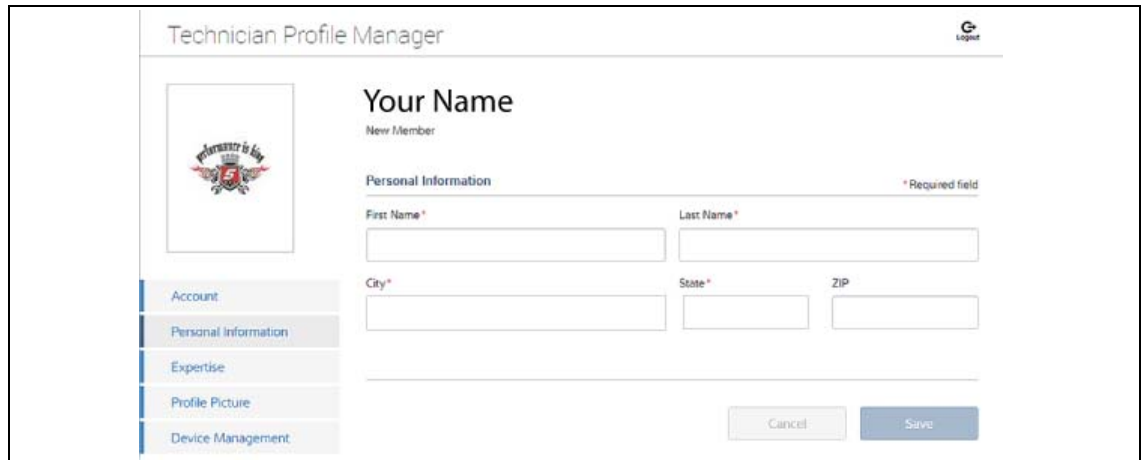

Figure 8-16

### Expertise

(SureTrack users only) - Select the vehicles from the list that you have expertise with. When a question is asked within the SureTrack community about one of the selected vehicles, you will receive an email with the details and a link back to the question.

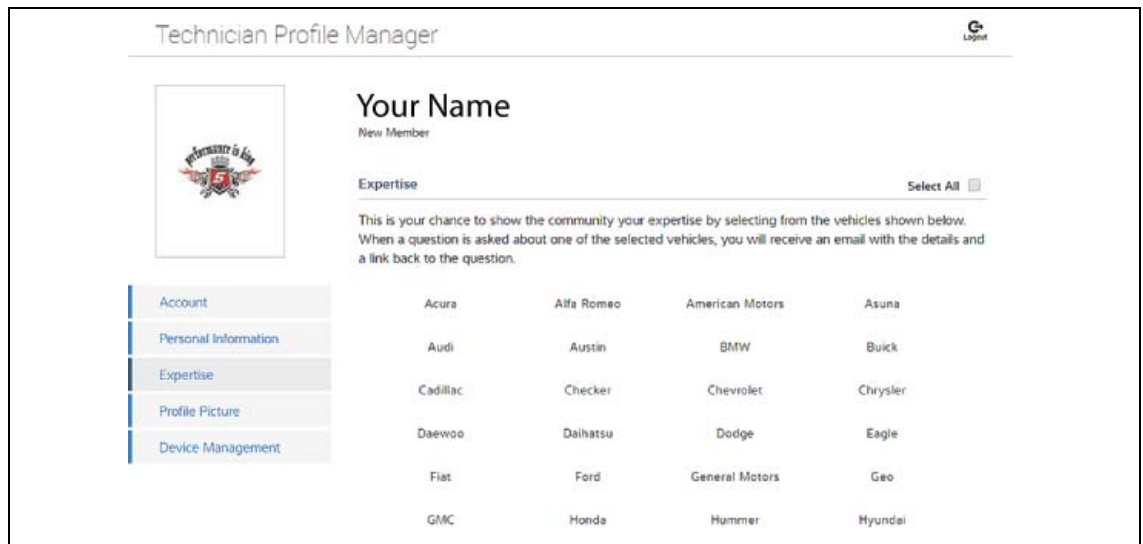

Figure 8-17

**Profile Picture**

This screen allows you to personalize your profile picture, by selecting one of the provided images.

**Device Management**

This screen manages devices associated with your account (Figure 8-18):

Select **Add a Device** to setup and add an authorized device (e.g. Diagnostic Thermal Imager or Diagnostic Tool).

Enter the device:

- **Serial Number** - serial number of the device
- **Code** - authorization code specific to the device
- **PIN** - specific PIN associated to the device
- **Device Name** - user define name

When finished select **Save** to save and link the device to your account.

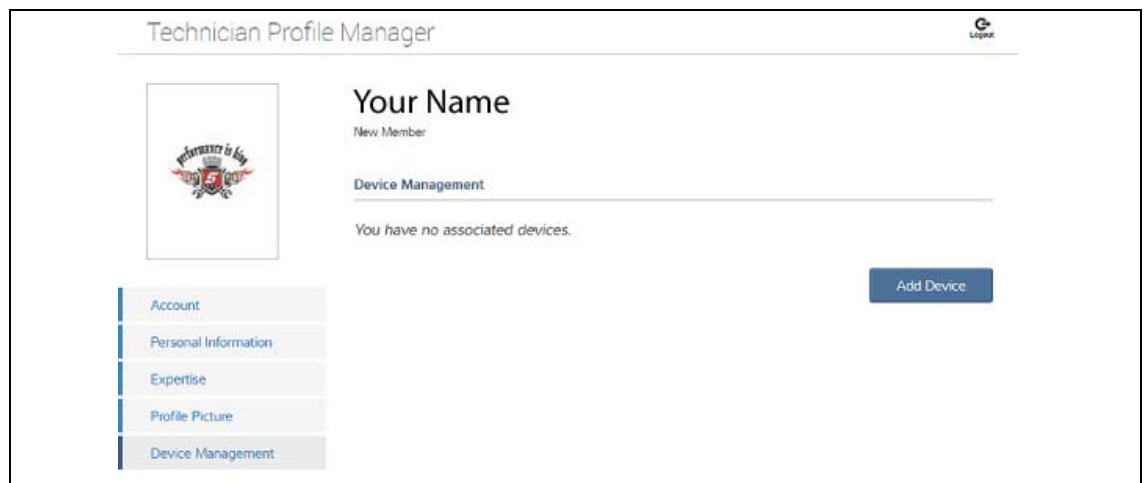

Figure 8-18

**Logging Out of Profile Manager**

Select the **logout** icon (upper right screen) to log out of Profile Manager (Figure 8-19).



Figure 8-19



**NOTE:**

Profile Manager opens a new browser tab. To return to ALTUS after logging out of Profile Manager, you must select the ALTUS Home Page browser tab.

## Logging Out of ALTUS

To log out of ALTUS select **Profile** from lower toolbar, then select **Logout** (Figure 8-20).

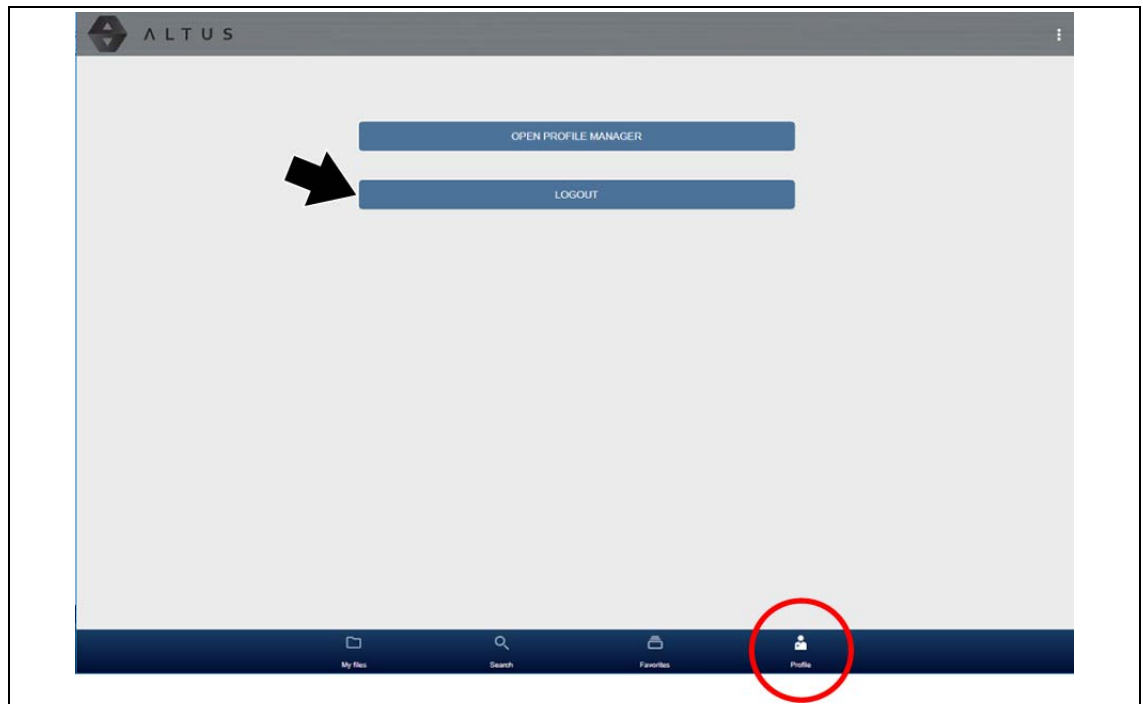

Figure 8-20

The information and examples in this chapter are provided to help you become familiar with some of the various uses of the Diagnostic Thermal Imager.

**NOTE:**

The Expert Tips feature includes reference images of known good and bad vehicle components, see [Expert Tips / Demo](#) on page 37 for more information.

| Typical Automotive Component and System Checks  |   |
|---|---|
| <b>Powertrain &amp; Exhaust</b><br>(General Temperature Checks)                             | Ignition Coils and Exhaust Manifolds (misfire)                        |
|   | Catalytic Converter   |
|   | Pulleys/Bearings - Idler, A/C Compressor, Alternator, Water Pump, etc |
|   | Differential Bearings and Fluid                                       |
|   | Intercooler   |
|   | Radiator, Thermostat, Coolant Passages/Hoses/Control Valves           |
|   | Heated IAC  |
|   | Engine Block Heater   |
|   | O2 Sensor Heater  |
|   | Glow Plugs  |
|   | EGR   |
|   | Oil, Transmission and Inverter Coolers/Pumps                          |
| <b>Electrical</b> (General Temperature Checks<br>(Open, Short, High Resistance Conditions)) | Battery Cables, Wiring, Relays and Switches                           |
|   | Heated Seats, Mirrors, Wipers and Steering Wheels                     |
|   | Window, Seat and Wiper Motors   |
|   | Alternator Charging   |
|   | Rear Window Defroster   |
|   | MAF (Hot Wire)  |
| <b>Body</b> (Leak Checks)   | Cabin   |
|   | Windows/Doors   |
|   | Sunroof   |
| <b>Chassis &amp; Brakes</b><br>(General Temperature Checks)                                 | Bearings  |
|   | Brake Rotors/Calipers   |
|   | Brake Drums   |
|   | Uneven Tire Wear  |
|   | Power Steering Cooler/Lines   |
|   | Driveshaft Center Support Bearing                                     |

| Typical Automotive Component and System Checks       |   |
|--|---|
| <b>HVAC</b><br>(General Temperature and Leak Checks) | General HVAC Conditioned Air Supply Temperature |
|  | Condenser/Compressor                            |
|  | High and Low Pressure Lines (A/C)               |
|  | Blend Doors                                     |
|  | Heater Core                                     |
|  | Blower Motor                                    |

| Typical Motorcycle Component Checks   |   |
|---|---|
| <b>Powertrain &amp; Exhaust</b><br>(General Temperature Checks)                             | Cylinder / Exhaust temperature (misfire)                |
|   | Exhaust Leaks   |
|   | Radiator, Thermostat, Coolant Passages/Hoses            |
|   | Drive System  |
| <b>Electrical</b> (General Temperature Checks<br>(Open, Short, High Resistance Conditions)) | Battery Cables, Wiring, Connectors, Relays and Switches |
|   | Heated Seat and Grips                                   |
| <b>Chassis &amp; Brakes</b><br>(General Temperature Checks)                                 | Bearings  |
|   | Brake Rotors/Calipers                                   |

## 9.1 Examples

The thermal images in this section have been modified for clarity. The temperature values, target indicator and color palette have been removed.

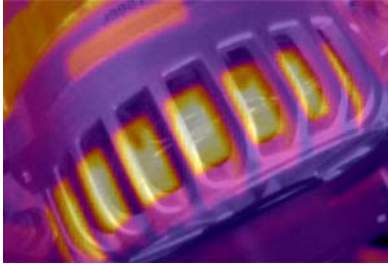
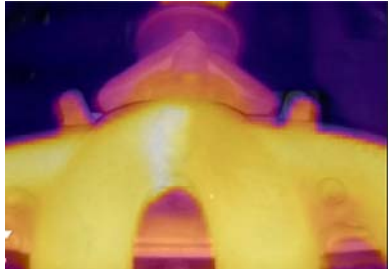
| Description                  | Thermal Image Example  |
|------------------------------|--|
| <b>Alternator Operation</b>  |  |
| <b>Exhaust Manifold Leak</b> |  |

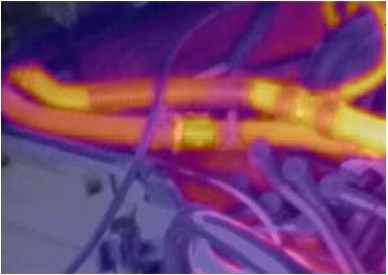
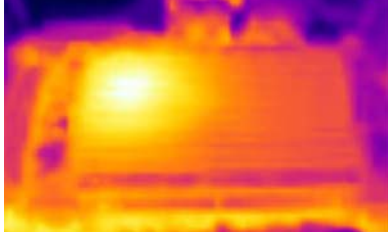
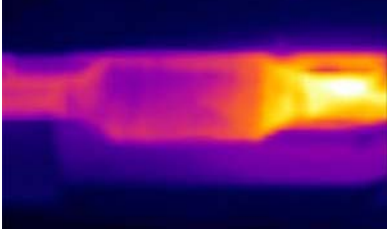
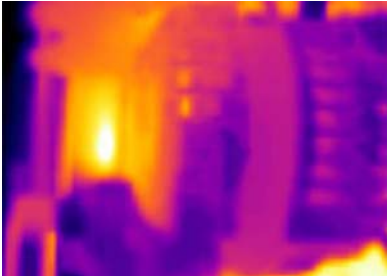
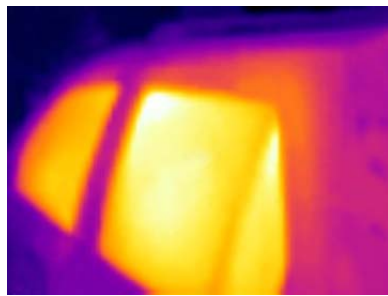
| Description   | Thermal Image Example  |
|---|--|
| <p><b>Coolant Control Valve<br/>(Heater Core)</b></p> |    |
| <p><b>Intercooler</b></p>                             |    |
| <p><b>Catalytic Converter</b></p>                     |   |
| <p><b>Alternator Bearing</b></p>                      |  |
| <p><b>Cabin HVAC Leaks</b></p>                        |  |

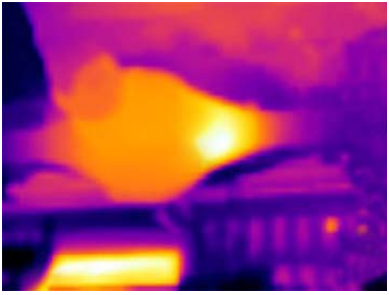
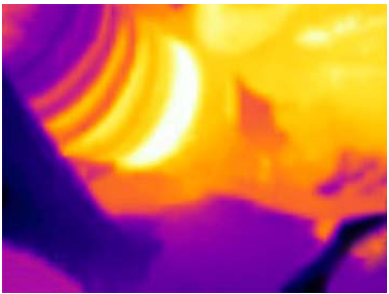
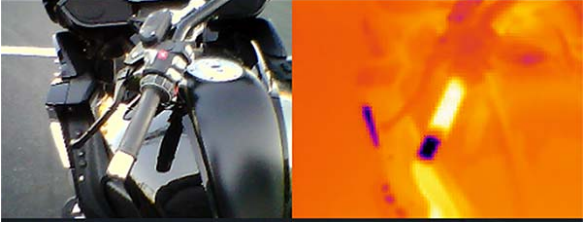
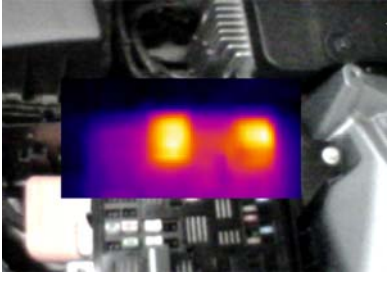
| Description   | Thermal Image Example  |
|---|--|
| <p><b>Heated Seats</b></p>                                    |    |
| <p><b>Differential Bearing</b></p>                            |    |
| <p><b>Wheel Bearing<br/>(Hub Assy.)</b></p>                   |   |
| <p><b>Motorcycle Heated Grip<br/>(Split-Screen)</b></p>       |  |
| <p><b>Electrical Relays<br/>(Picture-in-Picture view)</b></p> |  |

## 10.1 Main Topic Links

The following topics are described in this section:

- [Storage](#)
- [Cleaning](#)
- [Battery Pack](#)
  - [Safety Guidelines](#)
  - [Battery Charging](#)
  - [Removal / Installation](#)
  - [Ordering a Replacement Battery](#)
  - [Disposal](#)

## 10.2 Storage

To protect your Thermal Imager, store it in safe area free from dust, moisture and excessive temperatures.

- Only store the Thermal Imager in dry areas, at room temperature.
- During extended periods of non-use (long storage) remove the battery from the Thermal Imager.

## 10.3 Cleaning

Periodically perform the following tasks to keep your Thermal Imager in proper working order:

- Check the housing, display, and controls for dirt and damage before and after each use.
- Clean the Thermal Imager housing and display screen with a damp soft cloth and a weak detergent cleaner.

---

**IMPORTANT:**

Do not use paper towel or other paper type materials to clean the display screen.  
Do not use any abrasive cleansers or automotive chemicals.

---

---

**IMPORTANT:**

Only use cleaning solution specified for cleaning commercial digital camera lenses to clean the thermal imager and visible light lenses. Use extreme care when cleaning the lenses. Only use a cotton wool applicator and avoid touching the lens with your fingers. Oil or debris from your fingers may damage the lenses.

---



## 10.4 Battery Pack

### 10.4.1 Safety Guidelines

---

**IMPORTANT:**

The battery pack contains no user serviceable components. Tampering with the battery pack terminals or housing will void the product warranty.

---

Keep the following in mind when using and handling the battery pack:

- Do not short circuit battery pack terminals.
- Do not immerse the Thermal Imager or battery pack in water, or allow water to enter the Thermal Imager or battery pack.
- Do not crush, disassemble, or tamper with the battery pack.
- Do not heat the battery pack to over 100°C (212°F), or dispose of it in a fire.
- Do not expose the battery pack to excessive physical shock or vibration.
- Keep the battery pack out of reach of children.
- Do not use a battery pack that appears to have suffered abuse or damage.
- Charge the battery pack using the appropriate charger only.
- Do not use a battery charger adapter that has been modified or damaged.
- Use the battery pack for the specified product only.
- Store the battery pack in a cool, dry, well ventilated area.

Follow all safety guidelines when handling the battery pack. Read, understand and follow all safety messages and instructions in this manual, and in the *Important Safety Instructions* supplied with the Thermal Imager.

** WARNING**

Risk of electric shock.

- **Prior to recycling the battery pack, protect exposed terminals with heavy insulating tape to prevent shorting.**
- **Turn the tool off before removing the battery pack.**
- **Do not attempt to disassemble the battery or remove any component projecting from or protecting the battery terminals.**
- **Do not expose the tool or battery pack to rain, snow, or wet conditions.**
- **Do not short circuit the battery terminals.**

*Electric shock can cause injury.*

** WARNING**

Risk of explosion.

- **Only use the Snap-on lithium-ion battery approved for this device. Do not use any other battery or power adapter source. Incorrect replacement, charging, or tampering with the battery pack may cause an explosion.**

*Explosion can cause death or serious injury.*

## 10.4.2 Battery Information

The Thermal Imager is powered by an internal rechargeable battery pack, and has a built in charger that recharges the battery when connected to a power source. A fully charged battery pack can provide up to 4 hours of continuous operation. The battery discharge rate will vary depending on overall use and settings. For example, using the LED spotlight or a high level display brightness setting will accelerate battery discharge.

To prolong the life of your battery, turn off the Thermal Imager when not in use.

The battery pack should be used within a short period of time (about 30 days) after charging to prevent loss of capacity due to self-discharging.

If the battery pack no longer holds a charge, contact your sales representative to order a new one.

## 10.4.3 Battery Charging

There are three modes of charging:

- Low Rate (approximate charge rate 100mA)
  - Thermal Imager turned on
  - USB cable connected to a powered PC USB jack
- Medium Rate (approximate charge rate 500mA)
  - Thermal Imager turned off
  - USB cable connected to a powered PC USB jack
- High Rate (approximate charge rate 960mA)
  - Thermal Imager turned off
  - Using supplied or compatible USB power supply adapter connected to AC power source

A protective cover is used over the USB jack and microSD card slot, located on top of the Imager. Always keep the protective cover closed during operation. Only open the protective cover during battery charging, or when removing the microSD card. Opening the protective cover during operation could result in an electrostatic discharge event that may cause the Thermal Imager to reset. If this occurs, the Thermal Imager will reset and return to normal operation without being damaged.

**NOTE:**

When the battery reaches a low charge level (approximately one bar indication on icon), the LED flashlight is disabled.

---

1. Turn the LED spotlight off.
2. Open the protective cover on top of the Thermal Imager.
3. With the battery pack installed in the Thermal Imager, connect the USB cable to the micro USB jack on the Thermal Imager ([Figure 10-1](#)).

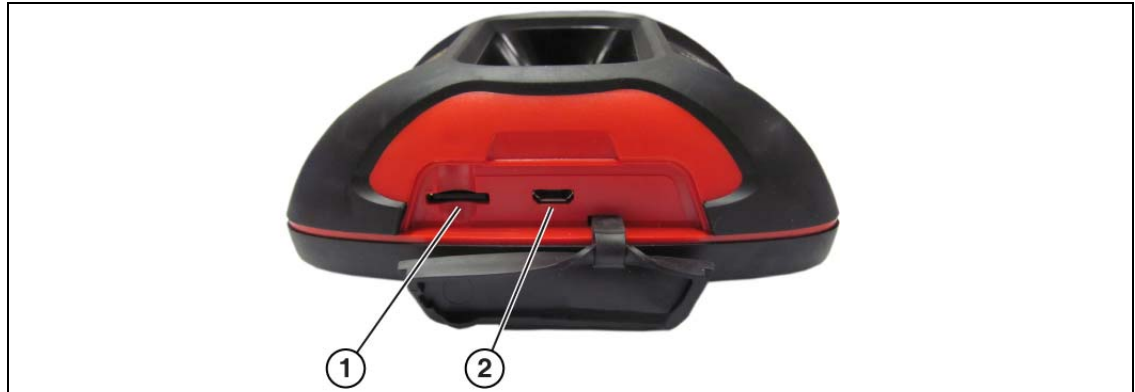

1— microSD Card

2— micro USB Jack (USB power supply connection)

Figure 10-1 Features (top)

**IMPORTANT:**

It is highly recommended to use the supplied USB power supply adapter to charge the battery. Using a non-approved power supply adapter (max. 500mA charge rate output) may result in insufficient charging.

4. Connect the USB cable to the USB power supply adapter.
5. Connect the USB power supply adapter, to a live AC power source.



**NOTE:**

The battery pack will also charge when the USB cable is connected to a PC (using the power supplied from the PC's USB connection).

The battery charge indicator LED is located on the front of the Thermal Imager above the control buttons (Figure 10-2). A red LED is turned on to indicate the battery is being charged. A green LED indicates the battery is fully charged.





1— Battery Level Icon

2— Battery Charge Indicator LED (Red-charging, Green-charged)

Figure 10-2

(Device on) A battery level icon is used to indicate the charge level of the battery, and when the battery is being charged (Figure 10-2).

| Icon  | Function   |
|---|--|
|  | <p>Indicates power is being supplied by the internal battery pack. Horizontal bars diminish as the battery discharges.</p> <p>When the battery charge level drops to approximately 10 minutes of power left, the icon will flash on/off as a reminder to connect the USB power supply adapter. If the charger is not connected, the unit will continue operate until it automatically turns off, due to low power. A warning message will be displayed before shutdown, "Low Battery - The unit will power down in 30 seconds, please connect to a charger."</p> |
|  | <p>Indicates power is being supplied by the USB power supply adapter to charge the battery pack.</p>   |

6. Close the protective cover, when finished.

### 10.4.4 Removal / Installation

**IMPORTANT:**

Replace the battery pack with a Snap-on replacement battery pack only.

1. Remove the screw at the rear of the battery pack cover, and pull the battery cover back and then up to remove (Figure 10-3).

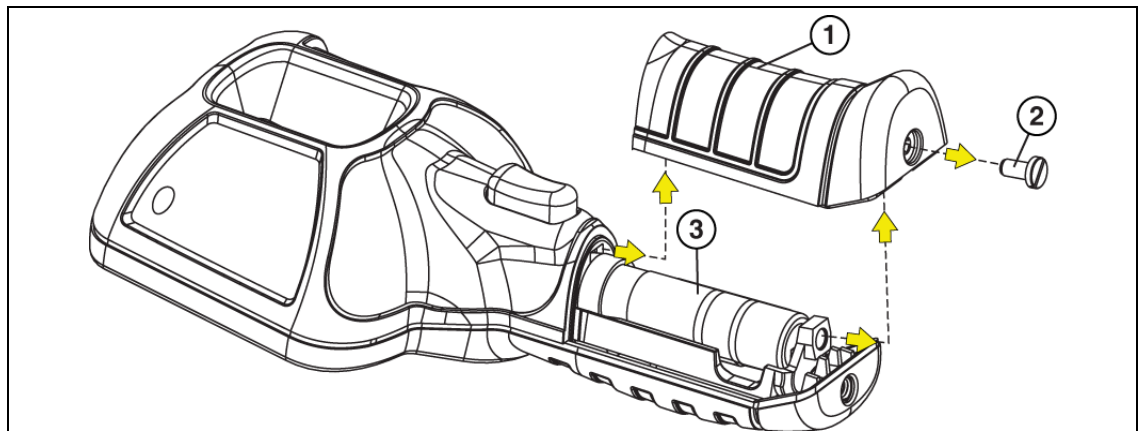

- 1— Battery Pack Cover
- 2— Battery Pack Cover Screw
- 3— Battery Pack

Figure 10-3

- Carefully lift out the battery pack, then press down on the battery lead connector release tab and remove the connector from the battery pack (Figure 10-4).

---

**IMPORTANT:**

Do not pull the battery harness out of the housing.

---

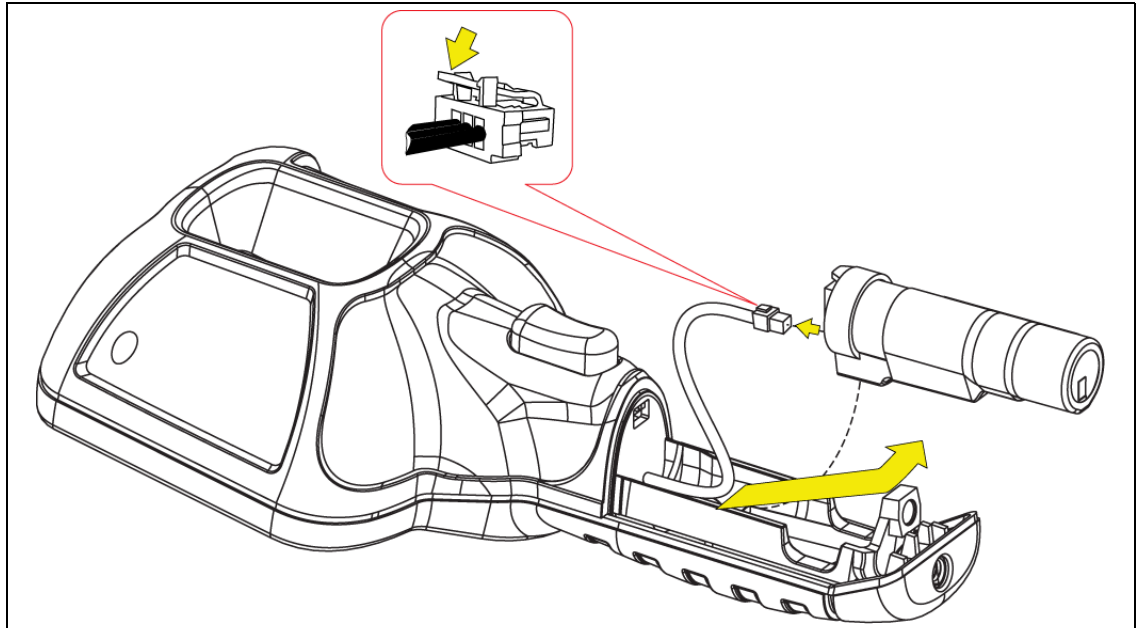

Figure 10-4

- Insert the battery connector into the battery pack, until it locks (clicks) into place.

**NOTE:**

Do not force the battery pack into the Thermal Imager, it should set easily into place.

---

- Feed the slacked harness into housing, as you install the battery pack into the housing (Figure 10-5).

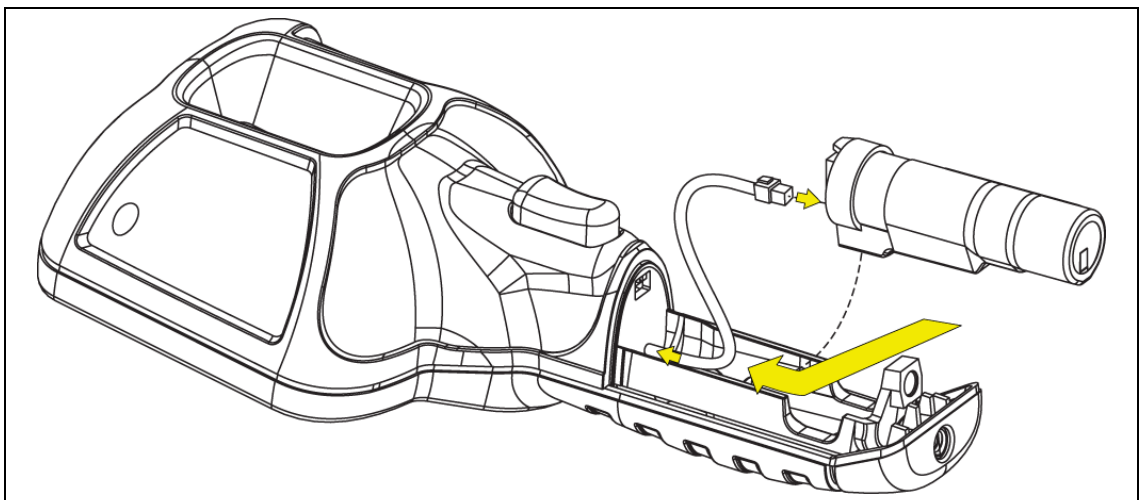

Figure 10-5

5. Install the battery cover. Press down until the locking tabs secure the cover (Figure 10-6).

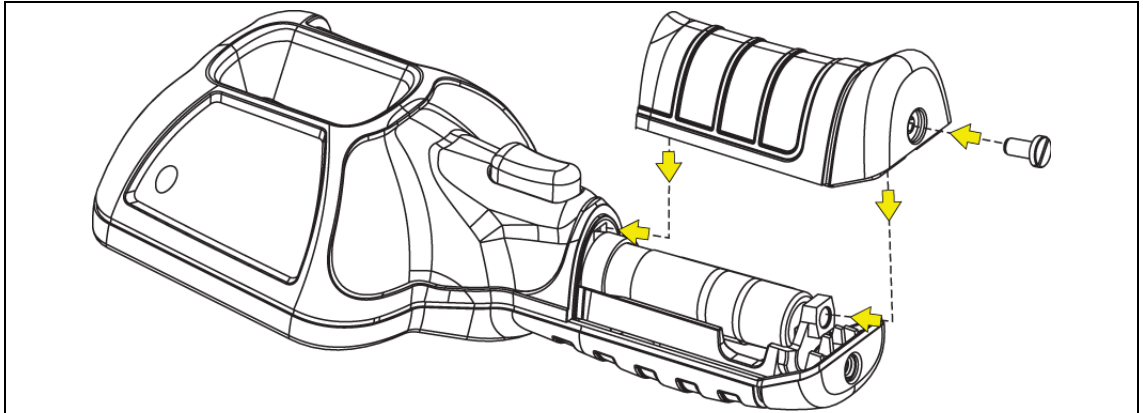

Figure 10-6



**NOTE:**

Date and time settings will need to be reset whenever the battery is reconnected after being disconnected.

### 10.4.5 Ordering a Replacement Battery

Contact your sales representative to order a replacement battery.

**IMPORTANT:**

Replace the battery pack with a Snap-on replacement battery pack only.

## 10.4.6 Disposal

Always dispose of a lithium-ion battery pack according to local regulations, which vary for different countries and regions. The battery pack, while non-hazardous waste, does contain recyclable materials. If shipping is required, ship the battery pack to a recycling facility in accordance with local, national, and international regulations. For additional information in the following markets contact:

- **North America**—Rechargeable Battery Recycling Corporation (RBRC) at <http://www.rbrc.org> or <http://www.call2recycle.org>, or call 1(800) 822-8837 (USA)
- **United Kingdom**—Electrical Waste Recycling Company at <http://www.electricalwaste.com>
- **Australia** - Australian Battery Recycling Initiative <http://www.batteryrecycling.org.au>
- **New Zealand** - Ministry for the Environment <https://www.mfe.govt.nz/issues/waste/streams/batteries.html>

Products bearing the WEEE logo (Figure 10-7) are subject to European Union regulations.

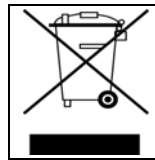

Figure 10-7 sample WEEE logo



**NOTE:**

Always dispose of materials according to local regulations.

---

Contact your sales representative for details.

## 11.1 General Troubleshooting Chart

| Problem  | Checks / Remedy  |
|--|--|
| Will not turn on   | a.) Battery is not installed or has become disconnected. Install the battery, or remove and reinstall the battery to establish connection  |
|  | b.) Battery is discharged or is defective. Recharge battery or replace with known good fully charged battery   |
|  | c.) Device or software may be damaged. Contact Customer Support.   |
| Battery performance is poor  | a.) Using incorrect or defective USB power supply adapter or cable to charger battery. Use the supplied USB cable and adapter  |
|  | b.) Battery may be defective. Replace battery.   |
| Poor or no image   | a.) Color palette setting is incorrect. Change the color palette setting.  |
|  | b.) Emissivity setting is incorrect. Change the emissivity setting.  |
|  | c.) Condensation or debris on imager window. Clean window or place imager in a dry area at room temperature until condensation clears.   |
| Temperature measurement is inaccurate  | a.) Emissivity setting is incorrect. Change the emissivity setting.  |
|  | b.) Condensation or debris on imager window. Clean window or place imager in a dry area at room temperature until condensation clears.   |
| Temperature measurement display is non-responsive  | a.) If the ">" symbol displays in front of the Center Region Temperature (Average) value, this indicates the maximum measurable temperature has been reached (e.g. >840°F (>450 °C)).  |
|  | b.) The Thermal Imager may be performing an automatic calibration. Wait a few seconds and retry, if still no response turn the unit off then back on.  |
| Image not being saved to microSD card  | When the microSD is full, and the screen capture trigger is pulled, the oldest saved image file will be deleted. To resume operation, delete images from the microSD card, or move them off the microSD card to a PC.  |
| Error message displayed - <b>"Disconnect the USB cable from the PC and retry"</b> or <b>"Unable to save image"</b> | When the Thermal Imager is connected by USB cable to a PC, saving and viewing images is disabled. If the screen capture trigger is pulled, or the gallery icon is selected while the USB cable is connected to a PC, an error message is displayed. To resume operation, disconnect the USB cable from the PC. |
| Error message displayed - <b>"microSD card is not installed"</b>   | The microSD card must be installed in order to save images and view expert tips. Install the supplied microSD card.  |













## 11.2 Wi-Fi Troubleshooting

The following troubleshooting information is not inclusive and is meant as a guide only. Other issues and solutions may arise that are not stated here. The following description of terms are provided for reference as used in the following troubleshooting chart:

- **Router** - The data transmission device directly connected to your ISP.
- **Remote Wireless Access Point** - A wireless connection device between the router and your diagnostic thermal imager.
- **Wi-Fi Radio** - The internal diagnostic thermal imager radio transmitting and receiving Wi-Fi signals.
- **Network Connection** - Also called Wi-Fi connection. The configured Wi-Fi router connection the diagnostic thermal imager connects to. This connection can be secured (password protected) or unsecured (open).

### 11.2.1 Wi-Fi - Icon Identification

The following chart shows the WI-Fi icons used to indicate connection status.

|  |  |   |   |
|--|--|---|---|
| Wi-Fi - ON / Connected to network access point and Internet  |   | Wi-Fi - ON / Alternate available network access point         |    |
| Wi-Fi - ON / Not connected to network access point or Internet   |    | Wi-Fi - ON / Network access point password protected          |   |
| Wi-Fi - ON / Connected to network, not connected to Internet   |   | Wi-Fi - ON / Actively connecting to network access point      |  |
| Wi-Fi - OFF  |   | Wi-Fi - ON / Actively disconnecting from network access point |  |
| Wi-Fi Signal Strength (general):<br><b>Three bars</b> - Full Strength Signal<br><b>Zero bars</b> - Weak Signal |   |   |   |

## 11.2.2 Wi-Fi Connection Status

To access the Wi-Fi Status screen:

1. Press the **Menu** button (Figure 11-1).



Figure 11-1

2. Select the **Settings** icon from the toolbar.
3. Select **Advanced** from the settings menu.
4. Select Wi-Fi Status.

The Wi-Fi Status screen (Figure 11-2) provides connection status indicators that can be used to troubleshoot Wi-Fi connection issues. Symbols are used to indicate status Yes/Connected (check mark), and No/Not Connected (“X” mark).

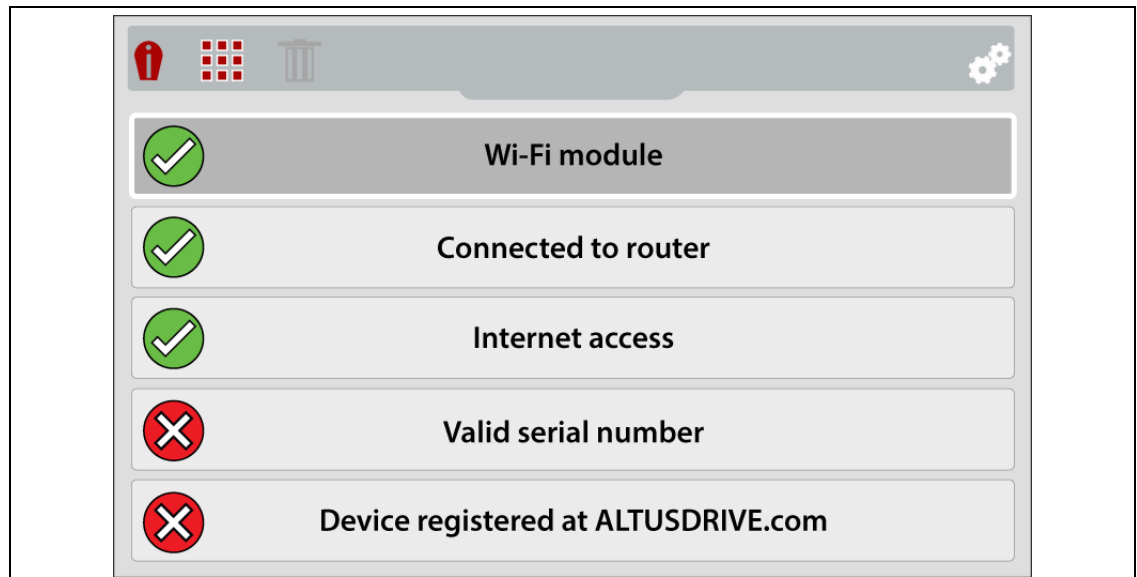

Figure 11-2

- **Wi-Fi module** - Wi-Fi radio (on / off)
- **Connected to router** (network access point) - Connected to the network access point or router (yes / no)
- **Internet access** - Connected to the Internet (yes /no)
- **Valid serial number** - Device serial number is valid (yes /no)
- **Device registered at ALTUSDRIVE.com** - Device is registered and authorized to connect to ALTUSDRIVE.com (yes /no)

### 11.2.3 Router Information

Router compatibility and setup are important factors to check when trying to determine connectivity problems. Although we have tested this device at the factory to verify connectivity, we cannot guaranty its connectivity with your specific equipment. There may be some situations that require your time for router connection troubleshooting and/or additional consultation and equipment. Snap-on Incorporated is not responsible for any costs incurred for any additional equipment, labor or consultation charges or any other costs that may result from correcting non-connectivity issues with this device.

### 11.2.4 Check Router Settings

Verify the following router settings **BEFORE** you begin troubleshooting a non-connectivity or “No Connection” problem. After each check, make any corrections as necessary then retest for connectivity. **Contact your IT administrator or ISP for assistance.**

1. Check your router connection and if applicable, the remote wireless access point connection.
2. Clear saved Wi-Fi networks, see [Clearing Wi-Fi Networks](#) on page 73.
3. Verify:
  - (a). Router is configured to use Dynamic Host Configuration Protocol (DHCP), not a static IP address.
  - (b). Router and/or settings for this device are configured to 2.4GHz. 5GHz is not supported.
  - (c). Router is configured to B/G and/or N standard wireless networks to 2.4GHz. 5GHz is not supported. See your router "User Guide" for setup, connection and troubleshooting procedures.
4. Check for router firmware and update to current version, if applicable.
5. Restart or reset the router. See your router "User Guide" for procedures.
6. Connect to a different router.

### 11.2.5 Clearing Wi-Fi Networks

1. From the Wi-Fi Connection menu, turn Wi-Fi off, see [Wi-Fi Connection](#) on page 20.
2. Turn the thermal imager off and then back on.
3. Return to the Wi-Fi Connection menu and turn Wi-Fi on.

### 11.2.6 General Wi-Fi Troubleshooting

| Problem   | Possible Cause                        | Corrective Action  |
|---|---------------------------------------|--|
| <b>No Connection with ALTUS (images are not uploading)</b>      | ALTUS account not setup or disabled   | 1. Check your ALTUS account and confirm the Device is correctly associated with the account.<br>2. Contact Customer Support.   |
|   | Access may be temporarily unavailable | Try to access the function at a later time as updates may be in process.   |
|   | Wi-Fi radio is turned Off             | 1. From the toolbar select the Settings icon.<br>2. Select Wi-Fi Connection from the menu.<br>3. Press the UP button to select the Wi-Fi Power icon, then press the Y button to turn Wi-Fi on.<br>4. Connect to a known good network.  |
|   | Not connecting to a network           | 1. Clear saved Wi-Fi networks, see <a href="#">Clearing Wi-Fi Networks</a> on page 73.<br>2. Connect to a known good network.  |
| <b>Wi-Fi connection drops off or disconnects intermittently</b> | Wi-Fi Signal strength insufficient    | Check Wi-Fi signal strength - out of range or interference. Move closer (within 50 Ft. (15 M) or into a direct open sight-line of the router or if applicable, remote wireless access point. Eliminate interference from overhead lights, windows, walls, other wireless devices, metal objects and devices that emit electrostatic discharge. |
|   | Router overloaded                     | Disconnect/disable other Wi-Fi devices connected to the router.  |